

REDLION™

a spectris company

///USAT///
Connect What's Critical™

Sixnet® Series

RAM® 9000

Cellular RTUs

Hardware Guide | February 2016

COPYRIGHT

©2015 Red Lion Controls, Inc. All rights reserved. Red Lion, the Red Lion logo and Sixnet are registered trademarks of Red Lion Controls, Inc. All other company and product names are trademarks of their respective owners.

Red Lion Controls, Inc.
20 Willow Springs Circle
York, PA 17406

CONTACT INFORMATION:

AMERICAS

York, PA: +1 (717) 767-6511
Mobile, AL: +1 (251) 342-2164
Ballston Lake, NY: +1 (518) 877-5173
Hours: 8am-6pm Eastern Standard Time
(UTC/GMT -5 hours)

ASIA-PACIFIC

Shanghai, P.R. China: +86 21-6113-3688 x767
Hours: 10am-6pm China Standard Time
(UTC/GMT +8 hours)

EUROPE

The Netherlands: +31 33-4723-225
Hours: 9am-6pm Central European Time
(UTC/GMT +1 hour)

Website: www.redlion.net

Email: customer.service@redlion.net

Preface	iii
Disclaimer	iii
Compliance Information	iii
Part 15 of the Federal Communications Commission (FCC) - A Rules: Interference	iii
Industry Canada	iii
Environmental Impact Statement	iii
Toxic Emissions	iii
Trademark Acknowledgments	iv
Release Notes and Document Updates	iv
Publication History	iv
Related Documents	iv
Document Ordering Information	iv
Document Comments	v
Additional Product Information	v
Safety Information	v
Warnings/Cautions/Notes	v
Hazardous Location and Installation Requirements	v
AVERTISSEMENTS POUR INSTALLATION ET ENDROITS DANGEREUX	v
Environmental	vi
Electrical	vii
Statement of Limited Warranty	ix
Chapter 1 Product Overview	1-1
RAM® 9000 Cellular RTU Product Highlights	1-1
Specifications	1-2
General Specifications	1-2
RAM 9000 Model Comparison Chart	1-6
RAM 9000 Cellular RTU View	1-7
Power Specifications and Consumption	1-7
Electrical Specifications and Pinout	1-8
Indicator Lights	1-11
Bootup LED Sequence	1-12
Data Interface Specifications: Serial, Ethernet & USB	1-13
Mode/Reset Button functions	1-14
Ordering Guide	1-17
Chapter 2 Hardware Installation	2-19
Mounting the RAM 9000 Cellular RTU	2-19
DIN Rail Mounting & Removal	2-19



Mechanical Dimension Diagrams	2-21
Antennas and Wireless	2-21
GPS Antenna	2-24
Installation and Verification	2-24
Wi-Fi Antenna	2-24
Ethernet cable	2-25
USB Device Cable	2-25
USB Host Cable	2-25
Serial RS485 Wiring	2-25
RS485 Wiring Diagram	2-27
Serial RS232 Cable	2-27
Power Source	2-28
Powering the unit	2-28
Testing the power connection	2-28
6-pin Screw Terminal	2-28
Power Input Diagram	2-29
Battery	2-29
Battery Removal and Installation:	2-30
SIM Cards	2-31
SD Card	2-32
I/O Wiring	2-32
I/O Wiring Diagram	2-33
Equivalent Circuit Diagrams	2-34
Thermal Performance and Considerations	2-34
Cleaning	2-35
Service and Support Information	3-37
Service Information	3-37
Product Support	3-37



Preface

Disclaimer

Portions of this document are intended solely as an outline of methodologies to be followed during the maintenance and operation of the RAM 9000 equipment/software. It is not intended as a step-by-step guide or a complete set of all procedures necessary and sufficient to complete all operations.

While every effort has been made to ensure that this document is complete and accurate at the time of release, the information that it contains is subject to change. Red Lion Controls is not responsible for any additions to or alterations of the original document. Industrial networks vary widely in their configurations, topologies, and traffic conditions. This document is intended as a general guide only. It has not been tested for all possible applications, and it may not be complete or accurate for some situations.

Users of this document are urged to heed warnings and cautions summarized at the front of the document, such as electrical hazard warnings.

Compliance Information

Part 15 of the Federal Communications Commission (FCC) - A Rules: Interference

Every effort has been made to ensure that this equipment is designed to comply with the limits for a Class A digital device, as described in the FCC Rules. This equipment has been tested and found to comply with the limits for a Class A digital device, pursuant to Part 15 of the FCC Rules. These limits are designed to provide reasonable protection against harmful interference in a residential installation. This equipment generates, uses, and can radiate radio frequency energy and, if not installed and used in accordance with the instructions, may cause harmful interference to radio communications. Operation of this device in a residential area is likely to cause harmful interference in which case the user will be required to correct the interference at his/her own expense.

Industry Canada

This Class A digital apparatus meets all requirements of the Canadian Interference Causing Equipment Regulations. Operation is subject to the following two conditions; (1) this device may not cause harmful interference, and (2) this device must accept any interference received, including interference that may cause undesired operation.

Environmental Impact Statement

Red Lion equipment contains no hazardous materials as defined by the United States Environmental Protection Agency (USEPA). Red Lion recommends that all failed product be returned to Red Lion for failure analysis and proper disposal.

Toxic Emissions

Red Lion equipment releases no toxic emissions.



Trademark Acknowledgments

- Windows® /98/2000/7/8, Windows XP® are registered trademarks of the Microsoft Corporation.
- Microsoft is either a registered trademark or trademark of Microsoft Corporation in the United States and/or other countries.
- Ethernet™ is a registered trademark of Xerox Corporation.
- EtherNet/IP™ and CIP™ are registered trademarks of ODVA™.
- All other company and product names are trademarks of their respective owners.

Release Notes and Document Updates

The hard copy and flash drive versions of this document are revised only at major releases and, therefore, may not always contain the latest product information. As needed, Application Notes and or Product Bulletins will be provided between major releases to describe any new information or document changes.

The latest online version of this document and all product updates can be accessed through the Red Lion web site at www.redlion.net/documentation

Publication History

The following information lists the release history of this document.

ISSUE/REVISION	RELEASE DATE	CONTENT DESCRIPTION
R06	February 2016	JP and 3.23/4.23 release.
R05	September 2015	EU release. Added uniform Warranty Statement and document template
R04	March 2015	Updates to Warnings
R03	September 2014	Modifications to FCC Statement to cellular frequency bands
R02	August 2014	Wi-Fi capability added. Change to operating temperature and thermal performance
R01	April 2014	First release

Related Documents

The following information lists available documents related to this product.

ISSUE/REVISION	RELEASE DATE	DOCUMENT TITLE
Version 7	February 2016	SN/RAM 6000 & RAM 9000 Software Manual
Version 6	March 2015	RAM 9000 Quick Start Guide
Version 6	February 2015	RAM 6000 Quick Start Guide



Document Ordering Information

To order additional documentation, the user can contact the local sales representative or Red Lion through the contact numbers and/or e-mail addresses listed on the back of the cover.

Document Comments

Red Lion appreciates all comments that will help us to improve our documentation quality. The user can submit comments through the Red Lion Customer Service. Simply email us at customer.service@redlion.net.

Additional Product Information

Additional product information can be obtained by contacting the local sales representative or Red Lion through the contact numbers and/or e-mail addresses listed on the back of the cover.

Safety Information



Must consult guide in all cases where this symbol is marked.

Warnings/Cautions/Notes

Warnings apply to situations where personal injury or death may result.

Cautions apply where damage to equipment may result

Notes apply where additional noteworthy information, not in the general text flow but applicable, is made available to the user.

Hazardous Location and Installation Requirements

These products should not be used to replace proper safety interlocking. No software-based device (or any other solid-state device) should ever be designed to be responsible for the maintenance of consequential equipment or personnel safety. In particular, Red Lion disclaims any responsibility for damages, either direct or consequential, that result from the use of this equipment in any application.

All power, input and output (I/O) wiring must be in accordance with Class I, Division 2 wiring methods and in accordance with the authority having jurisdiction.

Suitable for use in Class I, Division 2, Groups A, B, C and D hazardous locations, or non-hazardous locations only.

These products are operator interface units to be used within control panels in hazardous locations. The enclosure shall be suitable for the location.

AVERTISSEMENTS POUR INSTALLATION ET ENDROITS DANGEREUX

Ces produits ne doivent pas être utilisés pour remplacer le verrouillage de sécurité approprié. Aucun dispositif basé sur un logiciel (ou tout autre dispositif à l'état solide) devraient jamais être conçus pour être responsable de l'entretien de l'équipement consécutifs ou la sécurité du personnel. En particulier, Red Lion décline toute



responsabilité pour les dommages, directs ou indirects, résultant de l'utilisation de cet équipement dans n'importe quelle application.

Tout courant, câblage entrée et sortie (I / O) doit être conforme aux méthodes de câblage à la Classe I, Division 2 et conformément à l'autorité compétente.

Cet appareil est adapté pour utilisation en Classe I, Division 2, Groupes A, B, C, D endroits dangereux ou endroits non-dangereux.

Ces produits sont des unités d'interface opérateur qui doivent être utilisés à l'intérieur des panneaux de commande dans les endroits dangereux. L'enclos doit être adapté à l'environnement.



WARNING: Explosion Hazard – Substitution of components may impair suitability for Class I, Division 2.

AVERTISSEMENT - Risque d'explosion - La substitution de tout composant peut nuire à la conformité de Classe 1, Division 2.



WARNING – Explosion Hazard – When in hazardous locations, disconnect power before replacing or wiring modules.

AVERTISSEMENT – Risque d'explosion - Lorsque dans des endroits dangereux, débranchez le cordon d'alimentation avant de remplacer ou de brancher les modules.



WARNING – Explosion Hazard – Do not disconnect equipment unless power has been switched off or the area is known to be non-hazardous.

AVERTISSEMENT - Risque d'explosion - Ne débranchez pas l'équipement à moins que l'alimentation ait été coupée ou que l'environnement est connu pour être non dangereux.



WARNING - Explosion Hazard - Exposure to some chemicals may degrade the sealing properties of materials used in the relays.

AVERTISSEMENT - Risque d'explosion - L'exposition à certains produits chimiques peut dégrader les propriétés d'étanchéité des matériaux utilisés dans les relais.



WARNING - Explosion Hazard - Batteries must only be changed in an area known to be non-hazardous.

AVERTISSEMENT - Risque d'explosion - Batteries doivent être changées dans une zone connue pour être non dangereuse.

Environmental

The unit may become very hot to the touch in high temperature environments, so extreme caution should be exercised in handling when energized. The unit should be disconnected from power and allowed to cool for approximately 5 minutes before touching in high temperature applications.

	<p>WARNING: Disconnect the power and allow to cool 5 minutes before touching.</p> <p>AVERTISSEMENT: Déconnectez le câble d'alimentation et laissez refroidir 5 minutes avant de la toucher.</p>
---	---

Pollution degree: 2 (Per IEC 61010-1)

Electrical

	<p>WARNING: Device must be supplied by a Class 2 power source.</p> <p>AVERTISSEMENT: l'appareil doit être alimenté par une source d'alimentation de classe 2.</p>
---	---

	<p>WARNING: Properly ground the unit before connecting anything else to the unit. Units not properly grounded may result in a safety risk and could be hazardous and may void the warranty. See the grounding technique section of this manual for proper ways to ground the unit.</p> <p>AVERTISSEMENT: L'unité doit être correctement mise à la terre avant tout raccordement à l'unité. Unités pas correctement mise à la terre peuvent causer un risque de sécurité et pourraient être dangereuses et peuvent annuler la garantie. Voir la section technique de mise à la terre dans ce mode d'emploi pour des moyens appropriés à la masse de l'appareil.</p>
--	--

Over-voltage category: II (Per IEC 61010-1)

Statement of Limited Warranty

(a) Red Lion Controls Inc., Sixnet Inc., N-Tron Corporation, or Blue Tree Wireless Data, Inc. (the "Company") warrants that all Products shall be free from defects in material and workmanship under normal use for the period of time provided in "Statement of Warranty Periods" (available at www.redlion.net) current at the time of shipment of the Products (the "Warranty Period"). **EXCEPT FOR THE ABOVE-STATED WARRANTY, COMPANY MAKES NO WARRANTY WHATSOEVER WITH RESPECT TO THE PRODUCTS, INCLUDING ANY (A) WARRANTY OF MERCHANTABILITY; (B) WARRANTY OF FITNESS FOR A PARTICULAR PURPOSE; OR (C) WARRANTY AGAINST INFRINGEMENT OF INTELLECTUAL PROPERTY RIGHTS OF A THIRD PARTY; WHETHER EXPRESS OR IMPLIED BY LAW, COURSE OF DEALING, COURSE OF PERFORMANCE, USAGE OF TRADE OR OTHERWISE.** Customer shall be responsible for determining that a Product is suitable for Customer's use and that such use complies with any applicable local, state or federal law.

(b) The Company shall not be liable for a breach of the warranty set forth in paragraph (a) if (i) the defect is a result of Customer's failure to store, install, commission or maintain the Product according to specifications; (ii) Customer alters or repairs such Product without the prior written consent of Company.

(c) Subject to paragraph (b), with respect to any such Product during the Warranty Period, Company shall, in its sole discretion, either (i) repair or replace the Product; or (ii) credit or refund the price of Product provided that, if Company so requests, Customer shall, at Company's expense, return such Product to Company.

(d) **THE REMEDIES SET FORTH IN PARAGRAPH (c) SHALL BE THE CUSTOMER'S SOLE AND EXCLUSIVE REMEDY AND COMPANY'S ENTIRE LIABILITY FOR ANY BREACH OF THE LIMITED WARRANTY SET FORTH IN PARAGRAPH (a).**





Chapter 1 Product Overview

Using a single web-based user interface, our cellular units simplify I/O, network and security configurations to integrate complex hardware settings. This easy-to-manage configuration reduces the cost and complexity of deploying and administering multiple devices at remote locations. Furthermore, an integrated configurable stateful firewall provides intrusion protection and encrypted data access while a built-in Software Development Kit (SDK) enables users to develop custom applications.

Working in conjunction with SixView Manager remote monitoring and control software, RAM RTUs provide low-cost, real-time access to outlying sites.

RAM® 9000 Cellular RTU Product Highlights

- Supports Multi-Carrier 4G LTE connectivity with fall back to 3G (and 2G for non-EU/JP Models)
- Real-time access to mission-critical data through built-in Modbus gateway
- Software Development Kit (SDK) for custom application support
- Native support for DNP3 and Modbus protocols
- Integrated security firewall provides intrusion protection
- Simplified deployment and configuration with single web-based GUI
- Support for new and legacy devices with RS232/485 serial or RJ45 Ethernet
- Powerful event engine that can trigger built-in I/O, send SMS text or email alerts based on real-time operational data.



Specifications



General Specifications

Wireless Interfaces	AT&T LTE with fallback to HSPA+ (non-EU/JP models) Bell Mobility LTE with fallback to HSPA+ Generic LTE with fallback to HSPA+ Rogers LTE with fallback to HSPA+ TELUS LTE with fallback to HSPA+ Verizon LTE with fallback to EVDO (non-EU/JP models)
Programmable Platform	Configurable Events: up to 99 events can be triggered by I/O, Modbus registers, or over 200 system variables which in turn can send text messages, send email alerts or control I/O Software Development Kit (SDK) C/C++/Perl
Protocol Gateway	I/O Controller Modbus RTU/TCP/ASCII DNP3 - slave
System Performance	32-bit ARM9 400 MHz CPU 512 MB NAND Memory 128 MB RAM
Tunneling	IPsec, GRE, OpenVPN
IP	NAT, port forwarding, dynamic DNS, DHCP Stateful inspection firewall, IP Transparency
Routing Protocols	OSPF, BGP, RIP
Clustering	VRRP
GPS	GNSS supported: GPS L1, GLONASS L1, Galileo E1 High RF sensitivity plus jamming detection/removal
Connectors	Ethernet: One (1) or two (2) 10/100Base-T RJ-45 ports WAN capability on port 2 Serial: One (1) RS-232 (DB9) 115200bps One (1) RS-485 (screw block)115200bps USB: One (1) USB 2.0 (mini) Antennas: Three (3) SMA connectors (antenna, diversity, GPS) One (1) RP-SMA connector (Wi-Fi optional)



Inputs & Outputs	<p>2 Digital Inputs</p> <p>2 Digital Outputs</p> <p>3 Analog Inputs</p> <p>1 Form C Relay</p> <p>See detailed I/O specifications in Section 1.2.5 below</p>
Wi-Fi Interface (Optional)	<p>Complies with IEEE802.11b/g/n</p> <p>Maximum output power up to 25dBm</p> <p>Supports up to 150Mbps with 40MHz channel</p>
Power Input	<p>Input: 12-24 VDC</p> <p>Power consumption (less DO power):</p> <ul style="list-style-type: none"> • Standby: 4W (all models) • Transmitting: <ul style="list-style-type: none"> • 9911 & 9711: 5.0W - 9.4W (cellular only) • 9931 & 9731: 5.0W - 13.6W (cellular and Wi-Fi) <p>Power consumption of DO (max each):</p> <ul style="list-style-type: none"> • 0.7A/DO <p>Heat dissipation: 46 BTU/hour max; 20 BTU/hour typical</p>
Mechanical	<p>Dimensions: 132H x 127D x 70W mm (5.2" x 5.00" x 2.75")</p> <p>Material : Steel with black zinc coating</p> <p>Weight: 906 g (2 lbs)</p>
Environmental	<p>Operating temperature: -40°C to +75°C*</p> <p>Shock: IEC60068-2-27</p> <p>Vibration: IEC60068-2-6</p> <p>Humidity: 5 to 95% non-condensing</p> <p>Ingress Protection: IP30</p>
Ethernet Interface (10/100 Auto Sensing)	<p>1x or 2x RJ45 (Isolation 1500 Vrms 1 minute)</p> <p>WAN capability on 2nd port</p>
Serial interface	<p>1x RS232 Serial DB9 115200bps</p> <p>1x RS485 Serial Screws 115200bps (Isolation 1200 Vrms 1 minute)</p>
USB interface	<p>1x USB 2.0 Device mini</p> <p>1x USB 2.0 Host type A</p>
LED indicators	<p>Dual Power, Status Reset, WAN, RSSI, RS232, RS485, GPS, SD, Ethernet Link & Activity</p>



Certification	<p>EMI/EMC – Emissions: FCC, Part 15 and Industry Canada, ICES-003; Class A; EN55022, IEC61000-6-4 Immunity: IEC61000-6-2 (EN61000-4-2,3,4,5,6,8)</p> <p>Hazardous locations: Class I, Div. 2, Groups A, B, C, D, ANSI/ISA 12.12.01</p> <p>Electrical safety: UL508/CSA22.2/14 (CUL): IEC61010-1</p> <p>Carrier specific approvals (Contact Red Lion for latest)</p> <p>RoHS compliant</p>
ATEX	<ul style="list-style-type: none"> • Protection string:  II 3 G Ex nA IIC T3 Gc • ATEX Certificate string: DEMKO 15 ATEX 1366X • Ambient temperature ranges: <ul style="list-style-type: none"> • $-40^{\circ}\text{C} \leq T_{\text{amb}} \leq 75^{\circ}\text{C}$ for units utilizing Panasonic BR-1225A • $-40^{\circ}\text{C} \leq T_{\text{amb}} \leq 55^{\circ}\text{C}$ for units utilizing Rayovac BR1225X-BA • Conductor temperature of at least 107°C • Battery Replacement info: Replace w/ Panasonic BR1225A or Rayovac BR1225X-BA based on operating temperature given above. • Standards evaluated for ATEX: IEC 60079-0 6th Edition, IEC 60079-15 4th Edition, EN 60079-0:2012 + A11:2013, and EN 60079-15:2010 • The equipment shall be installed in an ATEX-Certified enclosure that provides a degree of protection not less than IP54 in accordance with EN/IEC 60079-15 and used in an environment of not more than Pollution Degree 2 in accordance with EN/IEC60664-1 when applied in Zone 2 environments. The enclosure must be accessible only by the use of a tool. • Conditions of Safe Use: Provision shall be made to prevent the rated voltage being exceeded by the transient disturbances of more than 140% of the peak rated voltage • Special Conditions of Use: Antenna Connections are for internal wiring only. • 
Compliances	<p>The Red Lion Sixnet Series RAM 9000 products meet the following standards plus others:</p> <p>Electrical Safety</p> <p>These devices have been designed to meet the basic safety requirements of the following standards:</p> <ul style="list-style-type: none"> • CE per Low Voltage Directive and IEC 61010-1 (CE applies only to the -EU models. Please contact Red Lion for availability) • UL508 (Industrial control equipment), ANSI/ISA 12.12.01 (Hazardous Locations) • CSA C22.2 No. 142 and No. 213 (per cUL)



EMC (emissions and immunity)

- CE per the EMC directive (CE applies only to the -EU models. Please contact Red Lion for availability)
- IEC 61000-6-2: Immunity in industrial environments
- IEC 61000-6-4: Emmissions in industrial environments
- FCC part 15 and ICES 003. See FCC statement on page 6.
- EN 55022 (CISPR22)

This equipment has been tested and found to comply with the limits for a Class A digital device, pursuant to part 15 of the FCC rules. These limits are designed to provide reasonable protection against harmful interference when the equipment is operated in a commercial environment. This equipment generates, uses, and can radiate radio frequency energy; and if not installed and used in accordance with the instructions, may cause harmful interference to radio communications. Operation of this equipment in a residential area is likely to cause harmful interference to radio communications, in which case the user will be required to correct the interference at their own expense. Warning: Changes or modifications to this unit not expressly approved by the party responsible for compliance could void the user's authority to operate the equipment.

Information to the user: If this equipment causes interference to radio or television reception, which can be determined by turning the equipment off and on, the user is encouraged to try to correct the interference by one or more of the following measures: In order to meet FCC emissions limits, this equipment must be used only with cables that comply with IEEE 802.3. If necessary, the user should consult the dealer or an experienced radio/television technician for additional suggestions. The user may find the following booklet prepared by the Federal Communications Commission helpful: "How to Identify and Resolve Radio-TV Interference Problems". This booklet is available from: U.S. Government Printing Office, Washington, DC 20402, Stock No. 004-000-00345-4



WEEE compliance

These devices comply with the WEEE directive. Do not throw away these devices in the standard trash. Contact Red Lion regarding proper disposal.



RoHS compliance

These devices comply with the RoHS directive and are considered lead and other hazardous substance free.

*-40°C to +75°C - See [Thermal Performance and Considerations section](#) in Chapter 2.

Note: All specifications are subject to change. Consult the Red Lion website for more information.



RAM 9000 Model Comparison Chart

Feature	RAM-9x01	RAM-9x11	RAM-9x31
Cellular	x = 6 for 3G (non-EU/JP models) x = 7 for 4G LTE (non-EU/JP models) x = 9 for 4G LTE+ (EU/JP models)	x = 6 for 3G (non-EU/JP models) x = 7 for 4G LTE (non-EU/JP models) x = 9 for 4G LTE+ (EU/JP models)	x = 6 for 3G (non-EU/JP models) x = 7 for 4G LTE (non-EU/JP models) x = 9 for 4G LTE+ (EU/JP Models)
Wi-Fi	-	-	1
GPS	1	1	1
Ethernet Port	1	2	2
RS232 Port	1	1	1
RS485 Port	1	1	1
USB Host Port	1	1	1
USB Device Port	1	1	1
SIM Card Slot	2*	2*	2*
SD Card Slot	1	1	1
Discrete Input	2	2	2
Discrete Output	2	2	2
Relay Output	1	1	1
Analog Input	3	3	3

* The second SIM slot is not currently active. This feature will be enabled in a future firmware release.

Contact Red Lion for availability of this feature.



RAM 9000 Cellular RTU View

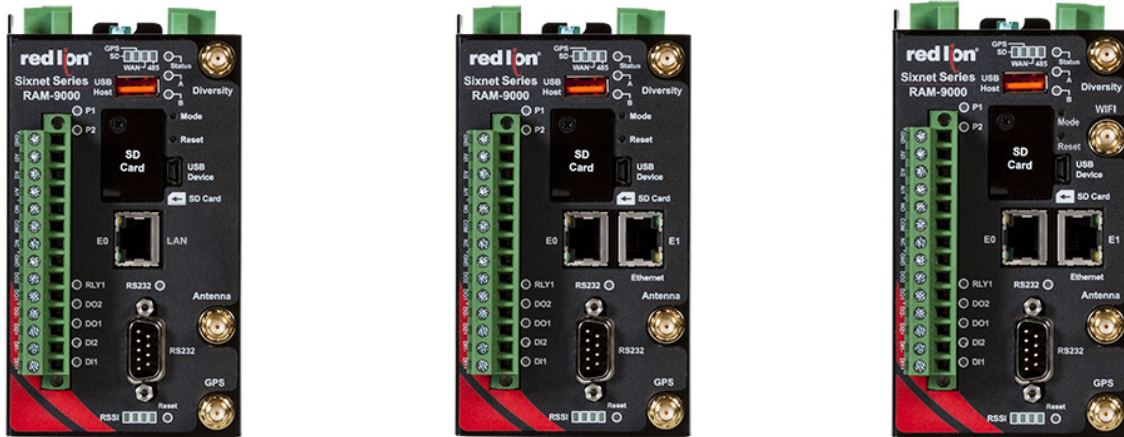

Power Specifications and Consumption

Power Input:

- Input: 12-24 VDC (absolute min./max.: 8-30 VDC)
- Power consumption (less DO power):
 - Idle: 4W
 - Typical: 5 - 6 W
 - Maximum: 6 - 14 W (depends on model)
- Power consumption of DO (max. each):
 - 0.7A/DO
- Heat dissipation: 46 BTU/hour max.; 20 BTU/hour typical

Power input to the unit is protected against reverse polarity and over-voltage up to 33VDC. The router's power consumption is as follows:

Typical Power Consumption (Watts)				
Model	Standby	Transmitting Minimum	Transmitting Maximum	Geographic Region
RAM-99x1	4.0	5.0	9.4	Non-EU
RAM-99x1-EU	4.0	5.0	9.4	EU
RAM-99x1-JP	4.0	5.0	9.4	JP



Typical Power Consumption (Watts)				
Model	Standby	Transmitting Minimum	Transmitting Maximum	Geographic Region
RAM-97x1	4.0	5.0	9.4	Non-EU
RAM-96x1	4.0	4.6	5.5	Non-EU
RAM-9931	4.0	5.0	13.6	Non-EU
RAM-9931-EU	4.0	5.0	13.6	EU
RAM-9931-JP	4.0	5.0	13.6	JP
RAM-9731	4.0	5.0	13.6	Non-EU
RAM-9631	4.0	4.6	9.7	Non-EU

Note: Wiring instructions are provided in [I/O Wiring section](#) in Chapter 2 of this guide.

To meet UL requirements, a "Class 2 Source" power supply is required.

Electrical Specifications and Pinout

Discrete Inputs:

- 2 Channels
- Isolated fully differential
- Isolation (channel to channel) = 1 KV
- Voltage range = 8-30 VDC
- Guaranteed ON voltage = 2.8 VDC
- Guaranteed OFF voltage = 2.7 VDC
- Input resistance = 315K Ohms
- Input current @ 24 VDC = 10 mA
- Filtered ON/OFF delay = 25 ms (10 Hz max count rate)
- Count resolution = 16 or 32 bits

Discrete Outputs:

- 2 Channels
- Sourcing of module power
- Max. output load per channel = 1 A (up to 35°C)



- Derate to 0.7 A up to 50°C
- Derate to 0.55 A up to 70°C
- Derate to 0.4 A up to 80°C
- Derate to 0.3 A up to 85°C
- Min. output load per channel = 1 mA
- Max. OFF state leakage current = <0.05 mA
- Inrush current (100 mA surge) = 5A
- Typical ON voltage drop (@1 A) = 0.13 VDC
- Short circuit protection = self-reset fuses (trip above 1.5 Amp at 20C)

Relay Outputs Specs:

- 1 channel
- Relay type = Form C (NO/NC)
- Minimum output voltage = 0 VAC/VDC
- Maximum output voltage = 110 VDC, 125 VAC
- Minimum switching capacity = 10µA, 10 mV DC
- Maximum load current per output (30 VDC) = 2 Amps
- Maximum load current per output (125 VAC) = 0.3 Amps
- Minimum OFF resistance = 1000 Meg Ohms
- Maximum relay turn ON time = 4 ms
- Maximum relay turn OFF time = 4 ms
- Load current versus contact voltage chart:

1. Max. switching capacity

* Max. switching capacity is 2A 30V DC.

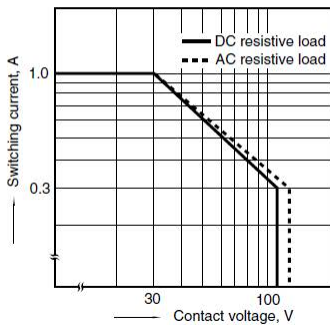

2. Life curve

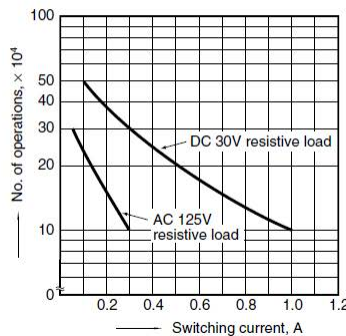

3. Mechanical life

Operating speed: 180 cpm

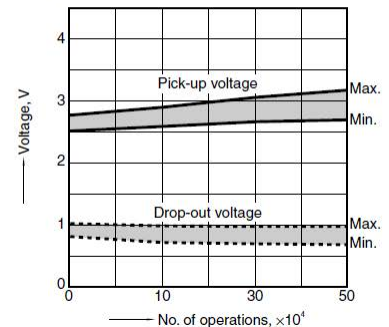

Analog Input Specs:





- 3 channels
- Ranges = 4-20 mA or 0-10 VDC
- Ranges are software selectable



- A/D resolution = 16 bits (0.003%)
- Input resolution = 2 uA or 0.5 mV
- Full scale accuracy (@20°C) (after field calibration) = +/- 0.1%
- Input span adjustability = +/- 25%
- Input offset adjustability = +/- 25%
- Span temperature coefficient +/- 50 ppm per °C
- Offset temperature coefficient +/- 50 ppm per °C
- Input impedance
 - Current ranges = 100 Ohms
 - Voltage ranges = 10K Ohms
- Current protection (current range) = self-resetting fuses
- DMRR at 50/60 Hz = 66dB
- Fastest update time = 120 ms per channel
- Self-calibration interval = 5 seconds



Indicator Lights

LED	Status	Corresponding State
P1	ON	Power is being applied to the primary input
	OFF	Power is not being applied to the primary input
P2 (Backup Power)	ON	Power is being applied to the secondary input
	OFF	Power is not being applied to the secondary input
SD	ON	SD Card mounted
	OFF	No SD Card mounted
GPS	ON	Position fix available
	OFF	No position fix available
WAN	ON	Cellular connection is established
	OFF	Cellular connection is not established
RSSI		Low Signal / No service
		≥ - 109 dBm (Low but valid signal)
		≥ - 99 dBm (Lower but valid signal)
		≥ - 89 dBm (Avg signal)
		≥ - 80 dBm (Excellent signal)
Reset	ON	Unit is booting. Not ready.
	OFF	Unit is functioning normally
Status	ON	Unit is booting up.
	OFF	Normal operation
	FLASH	Unit entering reflashing mode. Do not disturb.
	STROBE (Fast Flash)	System error. Contact Red Lion Technical Support.
Ethernet Link and Activity (Yellow)	ON	Link detected
	OFF	No link detected
	FLASH	Linked and active communications detected

LED	Status	Corresponding State
Ethernet Speed (Green)	ON	100 Mbps link speed detected
	OFF	10 Mbps link speed detected
RS485	ON	Serial connection is configured for use
	OFF	Serial connection is not configured for use
RS232	ON	Serial connection is established – with no data activity with host
	OFF	Serial connection is not established
	SLOW FLASH	Serial connection is established – with data activity with host
	STROBE (Fast Flash)	Unit is reflashing. Do not disconnect power!
RLY1	ON	The relay output is being activated. The Normally Open terminal will be ON (closed). The Normally Closed terminal will be OFF (open)
	OFF	The relay output is not being activated. The Normally Open terminal will be OFF (open). The Normally Closed terminal will be ON (closed).
DO1/DO2	ON	The corresponding discrete output is ON and sourcing power.
	OFF	The corresponding discrete output is OFF and not sourcing power.
DI1/DI2	ON	A valid voltage is detected on the corresponding discrete input.
	OFF	A valid voltage is not being detected on the corresponding discrete input.
A	Future	Reserved for future use.
B	Future	Reserved for future use.

Bootup LED Sequence

Stage 1: Power On

When the unit is first powered on, the P1/P2 LEDs will indicate that power has been detected.

Stage 2: CPU Initialized

The LED stacks on each side of the unit will scroll rapidly. When initialization is complete, all front LEDs will be on.



Stage 3: Kernel Loading

The Reset LED will turn off, but Status, A, B and RS232 will remain on.

Stage 4: Filesystem Mounted

The Status and RS232 LEDs will turn off and go into normal mode. A and B will remain on.

Stage 5: System services starting

The A and B lights will now turn off. All front panel LEDs should be in normal mode operation. Your unit should be fully functional within a few seconds.

Data Interface Specifications: Serial, Ethernet & USB

Ethernet Port

The unit's 10/100 Mbps port is compliant with the EIA-568 standard. The modem's ports are auto-sensing so they can be used with either a straight or crossover RJ45 cable to connect to host ports.

The RAM-9701 model has one Ethernet port and the RAM-9711, RAM-9731, RAM-9911, RAM-9911-EU, RAM-9911-JP, RAM-9931, RAM-9931-EU, and RAM-9931-JP models have two Ethernet ports.

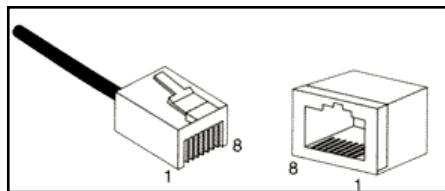
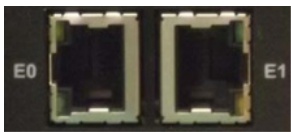

Ethernet Plug & Connector
Pin Positions

USB Device Port

This is a USB 2.0 Device interface on a Mini B connector. It offers Ethernet-over-USB RNDIS driver connection with all major operating systems. Driver installation and detection should be automatic on a properly configured Operating System.



USB Host Port

This is a USB 2.0 Host interface on a standard type A connector.

Specifications:

- USB Host USB 2.0 (1.5 / 12 / 480 MBit/s)
- Complies with Universal Serial Bus Specification Rev 2.0
- Hardware over current protected (1.0 A max per port)
- Increased Retention Connector (Complies with Class 1, DIV II minimum withdrawal requirement of 15N)
- Not electrically isolated
- Only use shielded USB standard cable
- Maximum cable length: 5 m



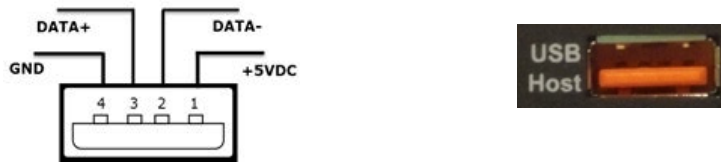

Note: No software functions have been defined for this port yet. This functionality will be available in a future firmware release.

Serial Port

The unit's serial port is an RS232 DTE, compliant with EIA-232 standard. The connector used is DB9 male and is shown in the illustration below.

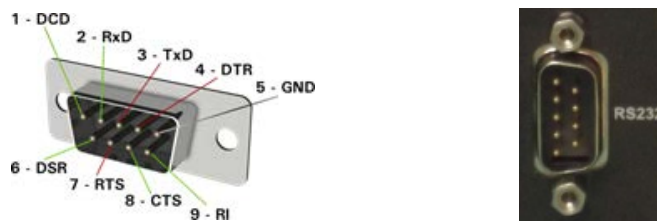

Serial Connector (looking at front of unit)

RS485 Port

The unit's RS485 serial port is for 2 wire, half-duplex connections up to 115,200 baud rate. This port is fully isolated up to 1200 Vrms (1 minute). A pluggable screw terminal is provided to make the RS485 connections. Refer to the RS485 wiring section for more details.



Mode/Reset Button functions

The Mode and Reset buttons are found on the front of the unit. Each is a momentary tactile button. It is recommended to use a straightened paper clip to press these buttons. Refer to the table below for the function of each button.

Reset Button

Function	Pattern	Description
Hard Reset	Press and hold for more than 7 seconds	Unit will perform a hard reset without a clean shutdown.



Mode Button

This button has 2 full feature sets depending on WHEN it is pressed: Boot time or Run time.





Boot Time: These features are only active at boot time. To use these features, power cycle your unit (or hold Reset) and immediately push and hold the Mode button for the desired function sequence listed below:

Function	Pattern	Description
Reset to Factory Defaults	Hold until RS485 LED flashes	Restores unit config to the original state.
Advanced Firmware Upgrade	Hold until WAN LED flashes	Sets the unit to automatically download firmware files using the advanced upgrade procedure.
RF module USB bypass mode: SIM1	Hold until GPS LED flashes	Puts modem into RF module USB bypass mode with SIM1 selected.
RF module USB bypass mode: SIM2	Hold until SD LED flashes	Puts modem into RF module USB bypass mode with SIM2 selected.







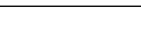
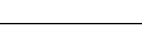



Run Time: These features are active during run time, once the unit is fully booted and idle.

Usage of the Mode push button, during normal runtime:

1. Hold in the Mode button for about 3 seconds until the 4 RSSI signal lights flash. The lights will then go dark. This is entering action selection mode.
2. Push the button 1 time to increment the action counter. Each time the button is pressed, the RSSI lights will increment once. The lights count in a binary pattern.
3. Once an action number is selected, the pattern on the light bar will flash. This indicates your action is executing.

Count	Pattern	Action	Description
0		None	No action will be performed
1		GatherStats	A GatherStats will be run and saved to ROM for further review. If a network connection is available, a copy will be sent to technical support. RSSI will scroll down while Gather-stats is running.
2		TriggerSVM	A Check-In will be triggered to all configured SixView Manager servers.
3		Reset Cellular	The cellular module will be reset.
4		Reboot Unit	Unit will be rebooted cleanly.
5		Ethernet restore	Eth0 and Eth1 will be temporarily restored to system default IP address. This will allow access to a known IP. This change is not saved and will be reverted after a reboot.



Count	Pattern	Action	Description
6		Backup Configs	A copy of the system configuration will be backed up to system storage.
7		Force Cell Provisioning	Force a cellular activation attempt. Verizon 3G only.
8		Force PRL Update	Force a cellular PRL Update. Verizon 3G only.
9		TBD	
10		TBD	
11		TBD	
12		User1	User Defined
13		User2	User Defined
14		User3	User Defined
15		User4	User Defined



Ordering Guide

Model Number	Series	Serial		Ethernet	Wi-Fi	Cellular	Power Connector	Default Carriers**
		RS-232	RS-485	10/100				
RAM-9911-xx	RAM	1	1	2 (WAN/ LAN)	N	4G LTE	DC powered	(AT) AT&T (VZ) Verizon (AM) Generic*
RAM-9931-xx	RAM	1	1	2 (WAN/ LAN)	Y	4G LTE	DC powered	(AM) Generic*
RAM-9911-EU	RAM	1	1	2 (WAN/ LAN)	N	4G LTE	DC powered	Generic
RAM-9931-EU	RAM	1	1	2 (WAN/ LAN)	Y	4G LTE	DC powered	
RAM-9911-JP	RAM	1	1	2 (WAN/ LAN)	N	4G LTE	DC powered	DoCoMo
RAM-9931-JP	RAM	1	1	2 (WAN/ LAN)	Y	4G LTE	DC powered	

* See Band/Frequency table for compatibility

** Carrier is pre-configured on device. Carrier can be selected via software.

Where xx = carrier code





Chapter 2 Hardware Installation

Mounting the RAM 9000 Cellular RTU

There are three different ways to mount a RAM 9000 series unit:

- Horizontally using two (2) screws (#6 up to #10) onto its horizontal mounting feet.
- Vertically using two (2) screws (#6 up to #10) onto its vertical mounting feet.
- Vertically on a DIN rail using the supplied DIN rail clip.

Note: Allow enough room to route the Ethernet, serial, I/O and other cables.

DIN Rail Mounting & Removal

The RAM 9000 has a DIN rail clip pre-mounted to the back of the unit. To panel mount the unit, the clip must be removed by removing the three (3) screws holding it in place. See the image at right for reference.

The DIN clip has an integral spring mechanism that keeps it securely attached to the rail. Refer to the diagrams below for how to mount and remove the unit to a standard EN50022 DIN rail.



Note: For best performance it is recommended that a DIN rail spacer (such as an end clamp) be used between the RAM 9000 and adjacent devices. This will leave an adequate air gap for proper heat dissipation away from the device case.

Mounting Instructions:

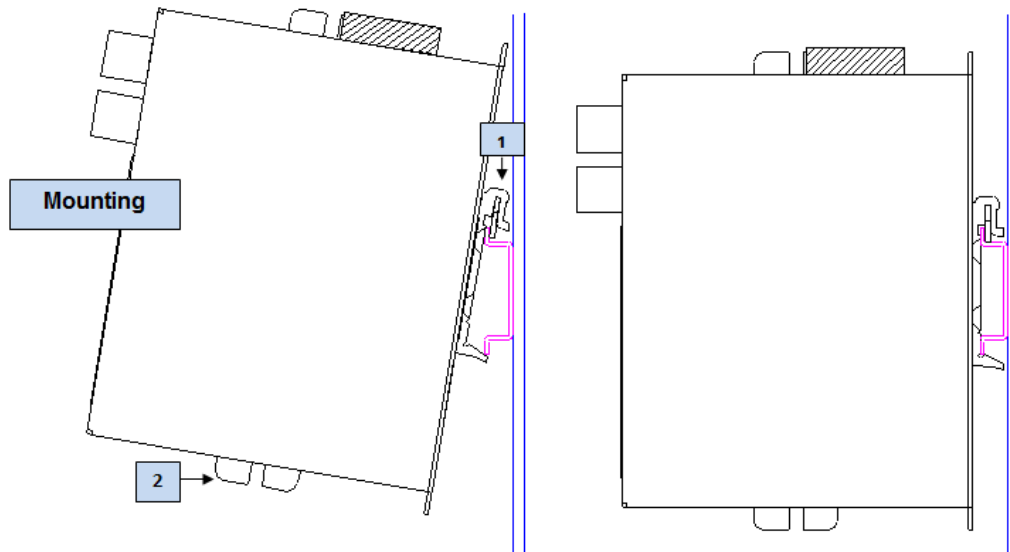

Recommended DIN Rail mounting steps:

1. Hook the top back of the DIN rail clips on the unit over the DIN rail.
2. Push the bottom of the unit towards the DIN rail unit it snaps into place.

Removal Instructions:

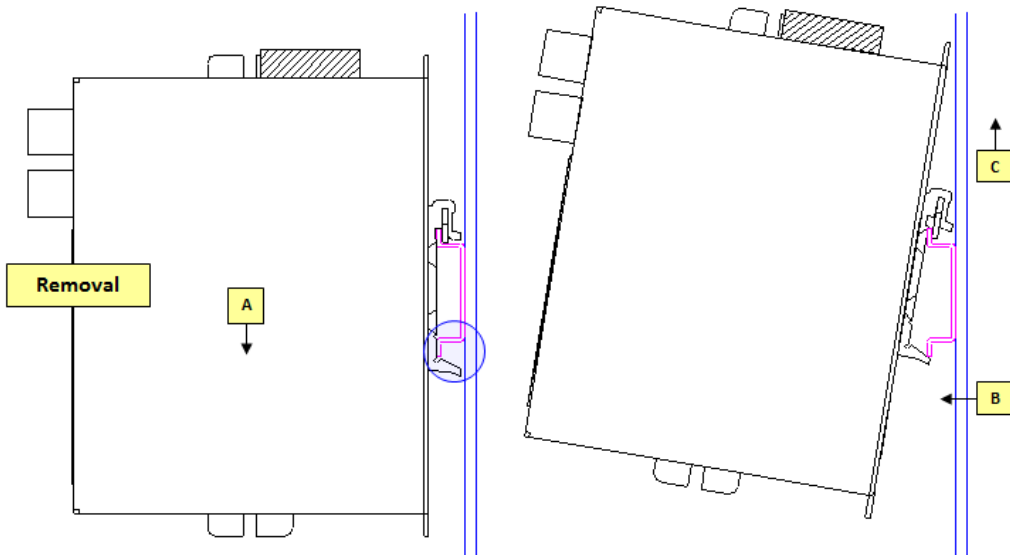

Recommended DIN rail removal steps:

- A. Push the whole unit down to free the bottom of the DIN rail clip. See blue circle area.
- B. Pull the bottom of the unit away from the DIN rail.
- C. Unhook the top of unit and remove it from the DIN rail

Mechanical Dimension Diagrams

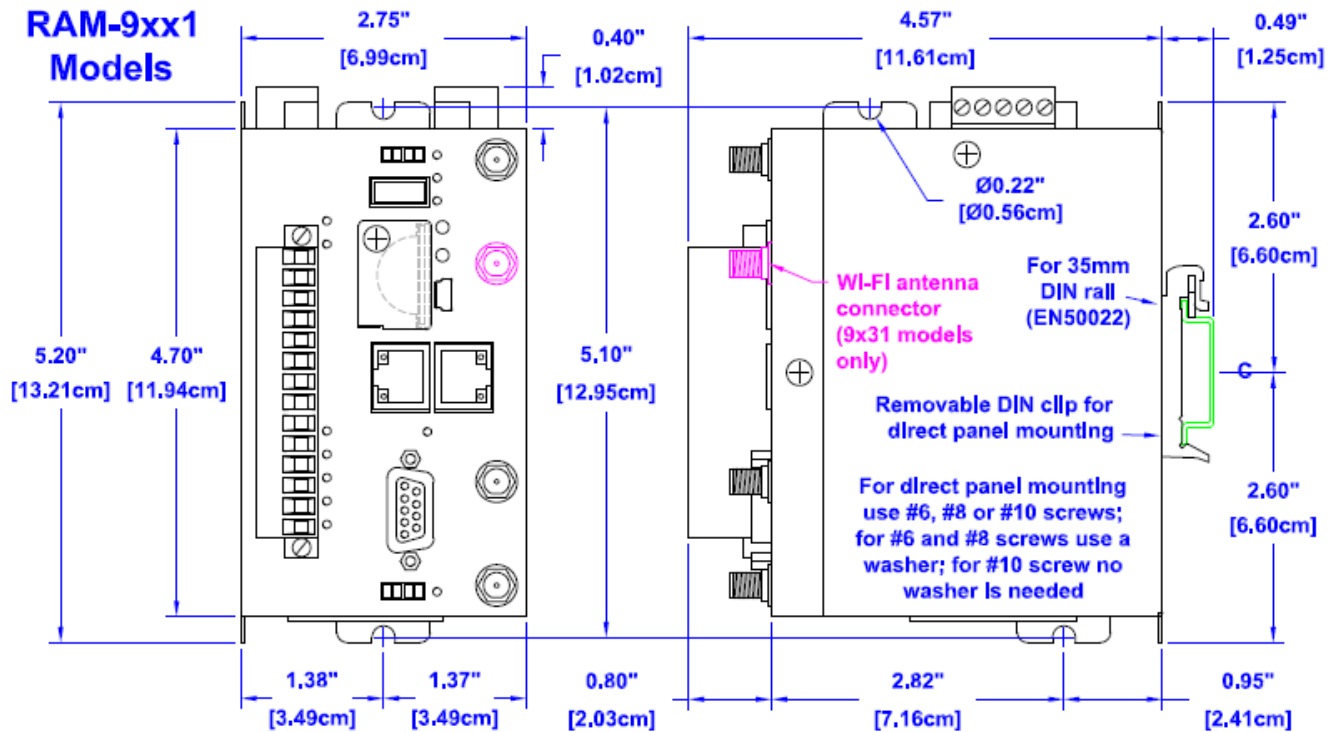

Antennas and Wireless



Warning: This device is not intended for use within close proximity of the human body. Antenna installation should allow for a separation of at least 20cm from all personnel.

Avertissement: cet appareil n'est pas conçu pour une utilisation à proximité du corps humain. Installation de l'antenne devrait permettre une séparation d'au moins 20cm de tout le personnel.

The Red Lion RAM 9000 series may have up to four (4) antenna connectors available, labeled Antenna, Diversity, GPS and Wi-Fi.

- **Antenna:** This is the main antenna that is used for data transmission. It is mandatory to have the Antenna port connected to an antenna.
- **Diversity/MIMO:** This port is used for RX diversity on 3G connections and MIMO for LTE connections. Receive Diversity or MIMO is a transmission technique that consists of using two separate antennas to achieve the most robust cellular signal possible. Diversity will help achieve fast, reliable data throughput in applications that require a high amount of bandwidth. This antenna is not mandatory for 3G, however it is recommended and will improve throughput in low signal and fringe areas. This antenna is required for compliance with LTE MIMO operation.

To get the best performance, this second antenna should be placed at a minimum of 5/8 of a wave length away from the other antenna. Therefore, the minimum spacing for antennas in the 800 MHz frequency is $5/8 * 13.5" = 8.5"$. The diversity antenna can be spaced further away than this, ideally in increments of 13.5", 22", 35", etc.



For a 1900 MHz only network, the optimal distance would be $5/8 * 6.2" = 4"$. Orienting the antennas differently from one another may also improve performance, particularly when the antennas are close together.

- **GPS:** This unit uses an active antenna only. It is used for receiving signals only. Please refer to the Red Lion [website](#) for information on GPS antennas.
- **Wi-Fi:** A reverse-SMA (female) connector is provided on the RAM-9x3x units that include Wi-Fi connectivity. Please use a 50 ohm cable and antenna that are rated for Wi-Fi connectivity per IEEE 802.11b/g/n. Please refer to the Red Lion [website](#) for information on Wi-Fi antennas.

Per FCC requirements the antenna gain including cable loss must not exceed 7.5 dBi in the Cellular band, 3 dBi in the PCS band, 5.5 dBi for LTE Band 4, and 9 dBi in the LTE Band 17 for RF exposure purposes of 2.1091. The antenna(s) used for this transmitter must be installed to provide a separation distance of at least 20 cm from all persons. The antenna(s) used for this transmitter must not be co-located or operating in conjunction with any other antenna or transmitter except in accordance with FCC multi-transmitter evaluation procedures.

Cellular Antenna and Cable Specifications

The selected cellular antenna(s) must meet the following specifications:

- Nominal 50 ohm impedance
- Voltage Standing Wave Ratio (VSWR) less than 2.5:1
- Male SMA connector

Frequency Specifications

RAM-96xx

Technology	Bands	Frequencies	Antenna Configuration
CDMA/EVDO	BC0, BC1	800/1900 MHz	Diversity Support

RAM-97xx

Technology	Bands	Frequencies	Antenna Configuration
LTE	1, 4, 17	700/1900 & 1700 (AWS)/ 2100(AWS) MHz	MIMO Required
Fallback HSPA+	1, 2, 5, 6	800/850/1900/2100	Diversity Support
Fallback GSM/GPRS/ EDGE	-	850/900/1800/1900 MHz	-



RAM-99xx

Technology	Bands	Frequencies	Antenna Configuration
LTE	2, 4, 5, 13, 17, 25	700/850/1900 & 1700 (AWS)/2100 (AWS) MHz	MIMO Required
Fallback CDMA/EVDO	BC0, BC1, BC10	800/1900 MHz	Diversity Support
Fallback HSPA+	1, 2, 4, 5, 8	850/900/1900/2100 & 1700 (AWS)/2100(AWS) MHz	Diversity Support
Fallback GSM/GPRS/EDGE	-	850/900/1800/1900 MHz	-

RAM-99xx-EU

Technology	Bands	Frequencies	Antenna Configuration
LTE	1, 3, 7, 8, 20	2100/1800/2600/900/800 MHz	MIMO Required
Fallback HSPA+	1, 2, 4, 5, 8	2100/1700/850/800/900 MHz	Diversity Support
Fallback GSM/GPRS/EDGE	-	800/900/1800/1900 MHz	Diversity Support

RAM-99xx-JP

Technology	Bands	Frequencies	Antenna Configuration
LTE	1, 19, 21	850/1500/1900/2100 MHz	MIMO Required
Fallback HSPA+	1, 5, 6, 19	800/850/2100 MHz	Diversity Support
Fallback GSM/GPRS/EDGE	-	850/900/1800/1900 MHz	-

The length of the antenna cable may affect the signal strength. Choose the appropriate cable type and length. The table below can help pre-determine the loss to expect.

Cable Type	Loss per 100 Feet
8216 (RG58)	31 dB
8267 (RG213)	7.6 dB
LMR-400	3.9 dB
LMR-500	3.15 dB
LMR-600	2.5 dB
LMR-1200	1.26 dB

dB loss per 100 feet of cable type



GPS Antenna

The GPS chipset used in this device supports a 50 ohm active GPS antenna and is capable of GPS and Glonass signal reception. Ascertain that the GPS antenna cabling uses an SMA-M type connector. For optimal results, the GPS antenna should be located so that it has clear and unobstructed access to the sky.

Installation and Verification

When installing the antenna, observe the [FCC and Industry Canada guidelines](#) and keep the following in mind:

- Mount the antenna(s) at least 30 cm (12 inches) from other antennas
- Do not install the antenna in a closed metallic enclosure (such as a cabinet or the trunk of a car).

Once an RTU has a signal, the RSSI LED bar will illuminate in stages according to the signal strength. Additionally, the Web Interface can display the received signal strength (RSSI) on the status page. The unit should have at the very least one bar of signal strength.

Wi-Fi Antenna

The Wi-Fi cabling and antenna must meet the following requirements:

- 50 ohm impedance
- RP-SMA (Male) connector
- Antenna designed for Wireless LAN or Wi-Fi
- Recommended antenna frequency rating: 2.4 GHz
- Recommended antenna bandwidth rating: 1.0 GHz

The Wi-Fi performance specifications of the RAM-9000 are shown in the table below:

Radio			
Output Power @ 25°C (±2dB)	IEEE 802.11b 11 Mbps: 23 dBm	IEEE 802.11g 6 Mbps: 23 dBm 54 Mbps: 21 dBm	IEEE 802.11n MCS0: 23 dBm @ HT20 / HT40 MCS7: 21 dBm @ HT20 / HT40
Sensitivity	IEEE 802.11b 11 Mbps: -90 dBm	IEEE 802.11g 6 Mbps: -92 dBm 54 Mbps: -75 dBm	IEEE 802.11n 2.4 GHz MCS0: -90 dBm (HT20) MCS7: -72 dBm (HT20) MCS0: - 88 dBm (HT40) MCS7: -68 dBm (HT40)
Operating Frequency	IEEE 802.11b/g/n 20 MHz ISM Band <ul style="list-style-type: none"> • USA (FCC): 2.412 GHz ~ 2.462 GHz (CH1 ~ CH11) • CD/CHINA: 2.412 ~ 2.472 GHz (CH1 ~ CH14)* IEEE 802.11g/n 40 MHz Band <ul style="list-style-type: none"> • USA (FCC): 2.422 GHz ~ 2.452 GHz (CH3 ~ CH9) • CE/CHINA: 2.422 ~ 2.462 GHz (CH2 ~ CH11) 		
Modulation	IEEE 802.11b (DSSS): CCK, DQPSK, DBPSK IEEE 802.11g/n (OFDM/DSSS): QAM-64, QAM-16, QPSK, BPSK		

*Geographic support for WiFi Channels : AM/AT and VZ = CH 1-11; EU = CH 1-13; JP = CH 1-14



Ethernet cable

If you are connecting to the unit via the Ethernet port, you will need a straight or crossover minimum category 5 cable with two 8-pin RJ45 connectors on each end.

To visually confirm that Ethernet cabling was done properly, check the LED indication on the Ethernet port of the unit. The link LED should be on when the correct cable is used and both ends are properly connected to active Ethernet ports.

Note: A shielded cable is required to fully meet EMC standards.

USB Device Cable

This is an Ethernet-over-USB connection which behaves like an Ethernet connection. It can be connected to a PC with all major operating systems. Driver installation and detection should be automatic on a properly configured OS. If you are connecting to the unit via the USB port, you will need a Type A plug to Mini-B plug USB cable.

USB Host Cable

This port will accept directly mounted devices such as a USB memory stick, wireless adapters, etc. Remote devices can be connected to by using a USB cable. The end of the cable that connects to the unit must be a standard USB Type A plug.

Note: No software functions have been defined for this port yet. This functionality will be available in a future firmware release. Contact Red Lion for expected availability.

Serial RS485 Wiring

RS485 connections are made to screw terminals on the top of the RTU. These terminals provide a RS485 (2-wire, half duplex only) connection to a network of RS485 devices connected in a bus topology, or a one-one-one connection to another RS485 device. Never connect RS485 devices in a star topology. Five terminals (for signal ground, voltage bias, termination, 485- and 485+) are provided. Generally, connect + to + and - to - between units, however since there is no standard for RS485 terminal designations you may need to connect + to - and - to + in some cases. No damage to the RTU will result if incorrectly connected. It is highly recommended that the signal ground (IGND) is tied to an appropriate ground (if available) between all RS485 units. The signal ground is fully isolated from the P1 and P2 ground and power. Make sure to use a good quality communication cable with three conductors (twisted is preferred) plus a shield. To prevent ground loops, the shield should be connected to chassis ground on only one end of any cable run.

Note: If you have existing wiring that has only two conductors and a shield, the shield to connect the signal grounds between stations can be used. This is not optimal (especially for long cable runs) but should work in most situations.

RS485 Termination: The RTU has RS485 termination components (120 ohm resistor and a capacitor connected in series) already inside. To terminate your RS485 network, tie the "TERM" terminal to the RS485 - terminal. Make sure to use the same type and size conductor as already used for the RS485 - connection. It is recommended that both end stations of the RS485 network be terminated. Termination is only needed at the stations on the endpoints of the bus, never terminate any of the other stations between the endpoints. For other devices, please refer to their user manual for termination instructions.



Bias Resistors: On a RS485 2-wire network, a pair of bias resistors (1K ohm typically) acting upon the transmit/receive wires may be required. If bias resistors are not present, the receive inputs on some RS485 devices may react to noise on the floating wires. The bias resistors will force the transmit/receive wires to a known (non-floating) state when none of the RS485 devices are transmitting data. Some RS485 devices have bias resistors built-in and are enabled through DIP-switch or jumper settings. Make sure there is only one pair of bias resistors acting upon the network. The RAM 9000 provides a way to easily connect external biasing resistors if needed. To bias the RS485+ connect a resistor of the desired value between the VBIAS terminal and the RS485+ terminal. To bias the RS485- connect a resistor of the desired value between the IGND terminal and the RS485- terminal. As mentioned above, 1K ohms is a typical value for a biasing resistor but other RS485 devices may recommend other values.

Note: The RAM 9000 RS485 port is designed in such a way as to never need biasing, but it includes the VBIAS screw as a convenience for use with 3rd party devices that require network biasing but lack the VBIAS connection. If the RS485 network is made up exclusively of RAM 9000 devices, then these bias resistors are not necessary.

	pin	name	description
 RS485 (Top of unit)	IGND	Isolated Ground	RS485 signal ground optically isolated from other ground.
	VBIAS	Voltage Bias	Connect to add RS485 Network Biasing.
	TERM	Termination	Connect to add RS485 Network Termination.
	485-	RS485-	Two wire RS485 negative terminal.
	485+	RS485+	Two wire RS485 positive terminal.

Note: Terminals are sized to hold 28 to 12 gauge wire, 12 AWG wire area is 3.31mm²

Torque spec for terminals is 0.5 Nm.

Use copper wire rated to 90°C or above. (For IECEx/ATEX use copper wire rated to at least 107°C)

RS485 Wiring Diagram

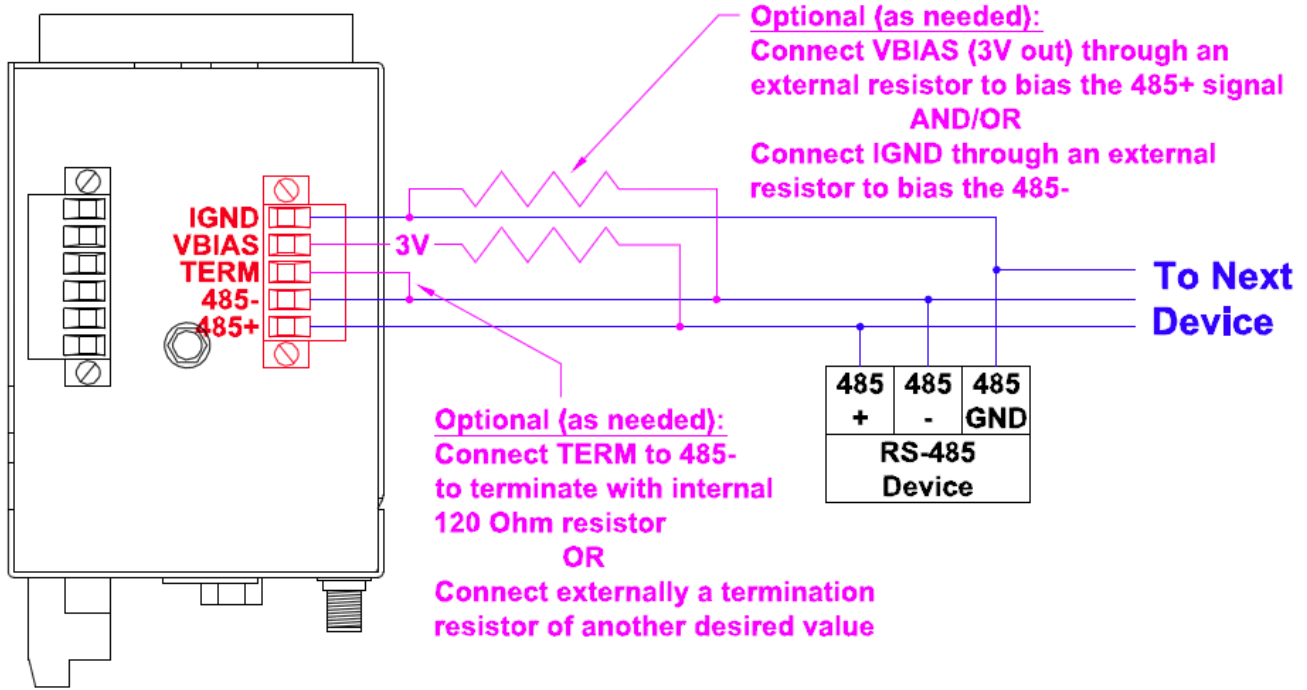

Serial RS232 Cable

The unit has a serial DTE RS232 port. In this port all of its serial port pins are enabled. If all the pins are enabled on the attached serial device, it is important to know whether the device is using DTE or DCE as a communication mode.

If using custom wiring or if some pins are disabled, follow the guidelines below. The wiring will vary depending on whether the attached serial device is a DTE or DCE.



Note: A shielded cable is required to fully meet EMC standards.



Power Source

Important

Any installation involving electrical wiring and connections should be done by someone who is experienced in this field. The safety of any system incorporating the equipment, is the responsibility of the assembler of the system.

Follow all local and national wiring codes.

Powering the unit

The unit will boot up as soon as power is applied to one of its power inputs and immediately shuts off when this input voltage is removed or drops below or around 7.4 VDC.

Testing the power connection



Check the P1 and P2 LED's on the RTU: if either or both are green, then the unit is powered. If both are OFF, then review the installation procedures or contact Red Lion Technical Support for further assistance.



Must consult guide in all cases where this symbol is marked.

6-pin Screw Terminal

Power is supplied to the unit via the 6-pin screw terminal on the top panel. Use copper wiring with a minimum insulation rating of 90°C. The pins are described as follows:

	Pin	Name	Description
 <p>Power Connector (top of unit)</p>	P1+	Power 1+	This is the primary power source positive (+) input.
	P1-	Power 1-	This is the primary power source negative (-) input.
		Chassis Ground	Tie to the panel or chassis ground.
	P2+	Power 2+	This is the secondary power source positive (+) input.
	P2-	Power 2-	This is the secondary power source negative (-) input.
		Chassis Ground	Tie to the panel or chassis ground.

Note: For best grounding, ground both chassis ground screws in the connector AND the ground screw next to the power connector.

To meet UL requirements, a "Class 2 Source" power supply is required.

Note: Terminals are sized to hold 28 to 12 gauge wire, 12 AWG wire area is 3.31mm².
Torque spec for terminals is 0.5 Nm.
Use copper wire rated to 90°C or above. (For IECEx/ATEX use copper wire rated to at least 107°C)

Power Input Diagram

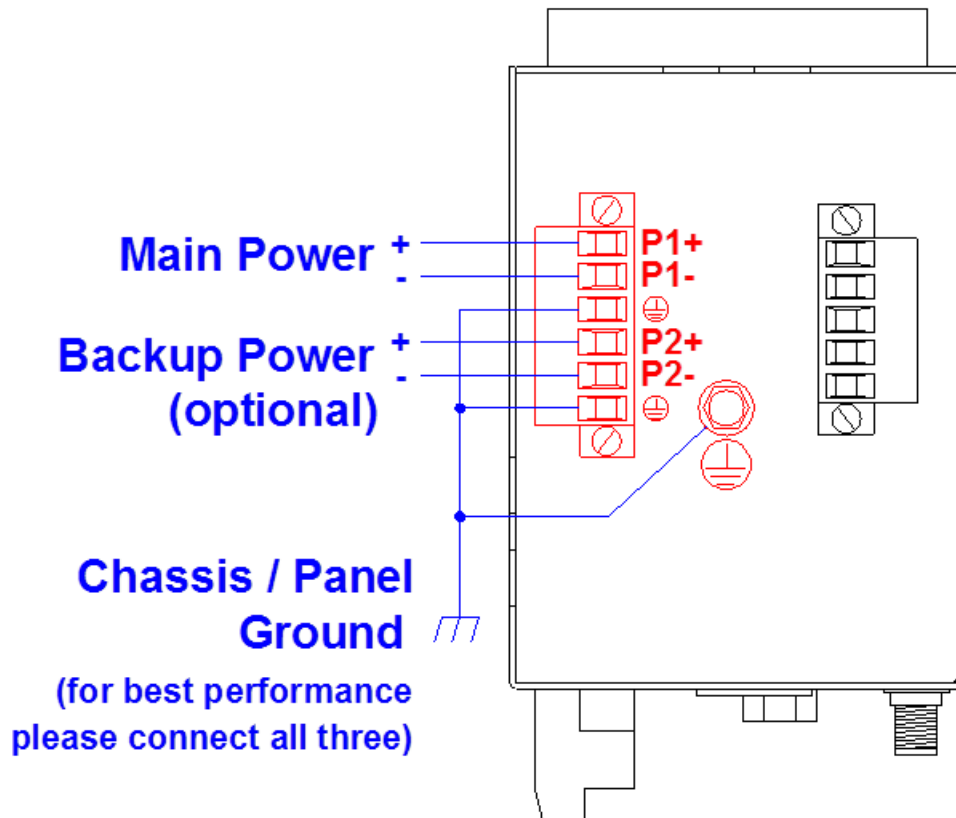

Battery

The battery is used to power the SRAM memory and the real-time clock when the unit does not have main power (at P1 or P2). When needed, replace the battery with a Rayovac BR1225X-BA or a Panasonic BR1225A/BN battery. The battery is located at the rear of the unit and is expected to last up to 9 months of the unit being continuously powered down. The battery is not being drained when the unit has power applied to either P1 or P2 or both. Under typical operating conditions the battery is estimated to last 5 years or more. However, it is recommended to replace the battery every 3 years to ensure no loss of functionality



Rayovac BR1225X-BA*
*Must use Rayovac battery for IECEx/ATEX areas up to 55°C



Panasonic BR1225A/BN**
**Must use Panasonic battery for IECEx/ATEX areas up to 75°C.

Note: The unit may ship with a battery pull-tab insulator in place that prevents the battery from discharging prior to first use. Remove the insulator when you are ready to install and use the unit. The insulator is removed by simply pulling it out.

Note: The battery does not provide power to the unit either as a main power source or as a backup. It only powers the SRAM memory and real-time clock, and only when there is no power supplied to either P1 or P2.

Note: For full temperature ATEX and/or IECeX compliance you must use a battery rated to 125C such as the Panasonic BR1225A/BN.

Battery Removal and Installation:

Step 1: Open Battery door on bottom of unit by removing the single screw.



Step 2: Insert a small flat-head screwdriver into the slot as shown below:



Step 3: Leverage back on the handle of the screwdriver to pop out the battery assembly:

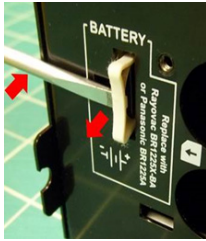

Step 4: Remove old battery from the holder and replace with a new battery of the proper type (see above).



Step 5: Insert battery holder with a new battery into the battery slot and push into slot until you hear and feel it snap into place:



Step 6: Replace the battery door.

SIM Cards

The RAM 9000 has 2 SIM card sockets. The SIM sockets are found under a panel on the bottom of the unit. Remove the one screw to access the SIM socket(s).



Note: The second socket (SIM2) is currently not supported. A future firmware release will be needed to support SIM2.

The SIM card sockets support the 2FF format Mini-SIM card.

SD Card

The RAM 9000 has an SD memory card socket. This socket is found under a small door in the front face of the unit. Remove the one screw to access the SD card socket. To install an SD card, insert in the orientation show on the label until you hear a click. The SD card when properly inserted should sit just behind the door as shown below. To remove the SD card push on the card until you hear a click, then remove pressure and the card will release.



I/O Wiring

The RAM-96xx, RAM 97xx, and RAM-99xx models offer 2 discrete inputs, 2 discrete outputs, 1 relay output and 3 analog inputs. The discrete inputs and outputs operate on the same voltage that powers the unit. The relay output can switch an external power source up to 125 VAC. The analog inputs can accept current(0/4-20 mA) or voltage (0-10 VDC) inputs. The range is selectable in the software configuration.

The pluggable screw block terminal is provided for the I/O wiring connections. Refer to the diagrams below on how to make your I/O connections.

Note: For relay wiring, use a minimum of 300V, 90°C rated wiring.

Note: For ATEX / IECEx purposes, the relays are not applicable.

Note: Terminals are sized to hold 28 to 12 gauge wire, 12 AWG wire area is 3.31mm².

Note: Torque spec for terminals is 0.5 Nm.

Note: Use copper wire rated to 90°C or above. (For IECEx/ATEX use copper wire rated to at least 107°C)



The relay cannot be used in IECEx and ATEX applications.

Le relais ne peut pas être utilisé dans des applications IECEx et ATEX.

I/O Wiring Diagram

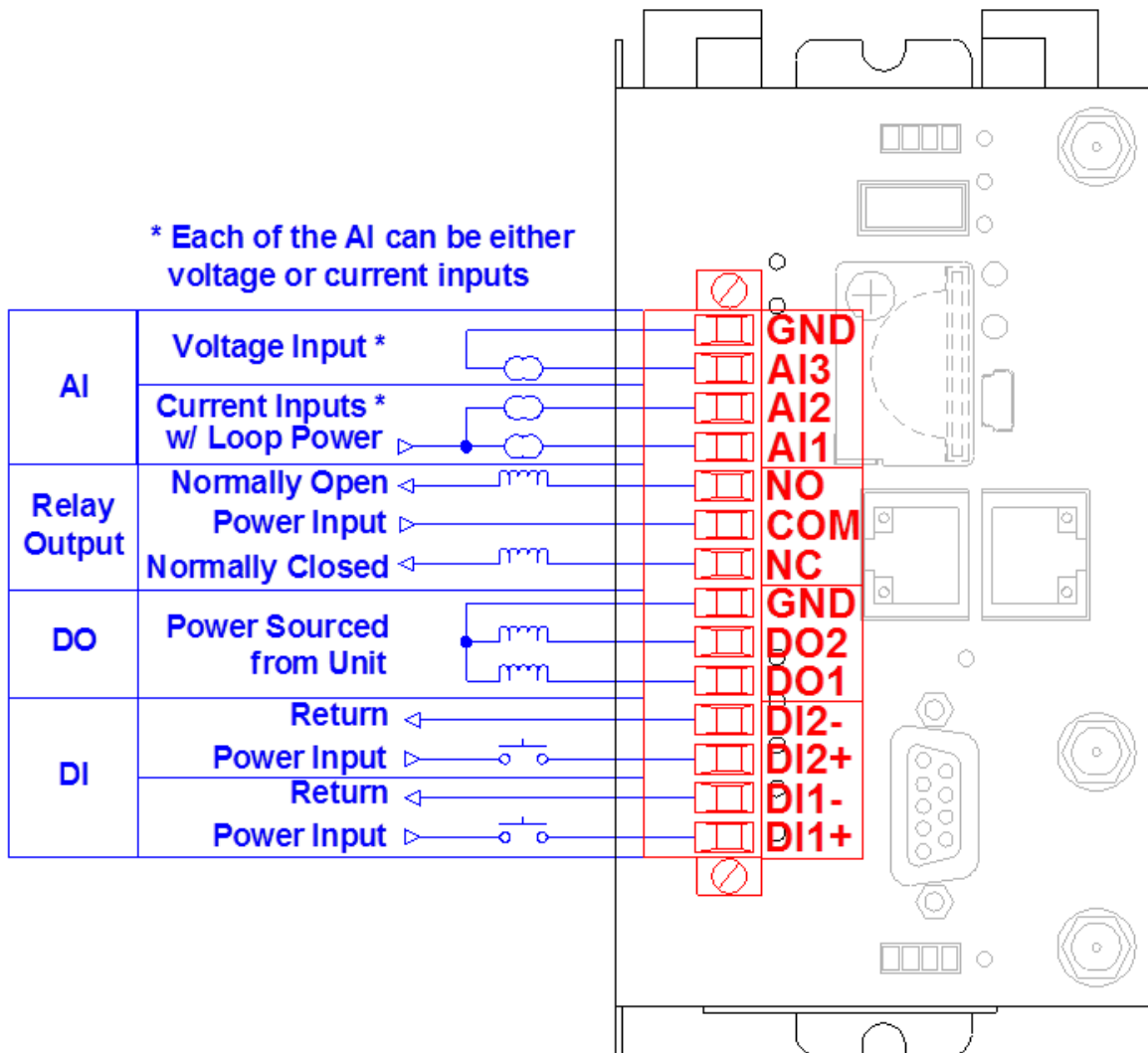

Equivalent Circuit Diagrams

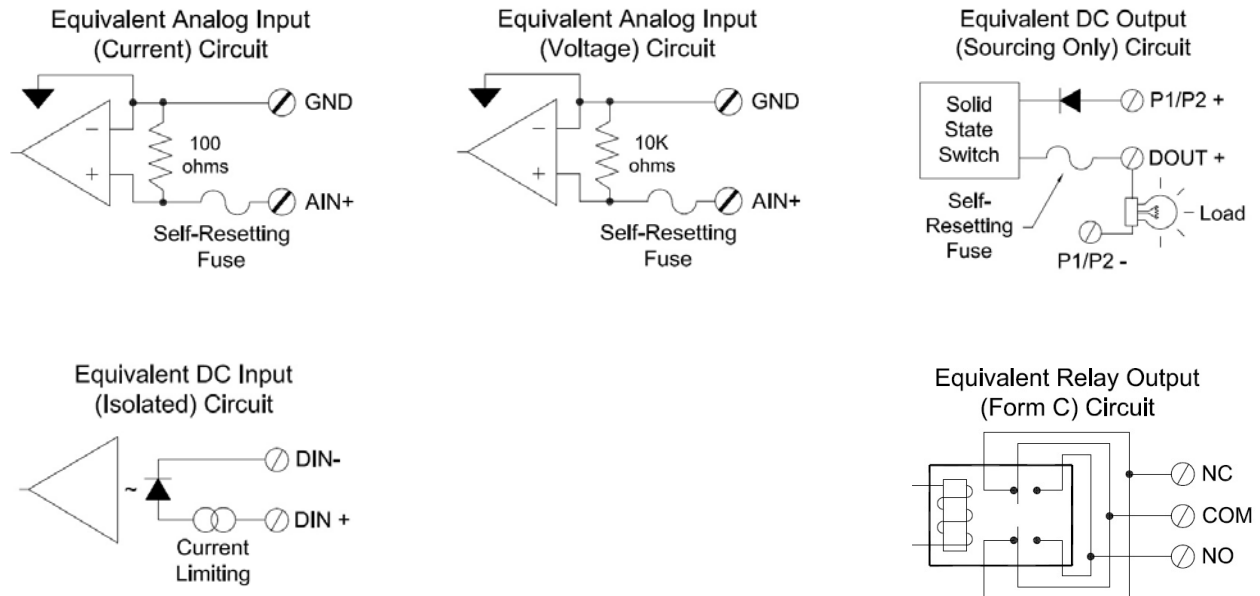

Thermal Performance and Considerations

These units are rated for operation from -40°C to $+75^{\circ}\text{C}$ when the proper thermal considerations are taken into account. Please refer to the following information to maximize the performance of these units when they are operated under extreme temperatures.

Hot Operating Conditions

These units have many modes of operation which can cause the power consumption and corresponding heat dissipation to vary greatly. This factor, along with others, can affect the performance and longevity of the unit. These units are rated for operation up to $+75^{\circ}\text{C}$ in typical applications where the wireless communication (cellular and/or Wi-Fi) is low to moderate.

The maximum temperature applies to the ambient which is defined as the temperature of the air immediately surrounding the unit. Though operating with an ambient temperature up to $+75^{\circ}\text{C}$ is allowed, for best performance and longevity it is recommended to keep the ambient air temperature at or below 60°C if possible. Reduced wireless performance may occur when operating above $+60^{\circ}\text{C}$.

Please note that the $+75^{\circ}\text{C}$ ratings are based on low to moderate wireless communications. If your wireless communications are typically high or frequent then the maximum ambient operating temperature may be reduced.

Here are some recommendations to reduce the ambient temperature around the unit for optimal performance and to prevent temperature related issues:

- Make sure other hot devices are not mounted immediately adjacent or below the unit.
- Use a DIN rail spacer between adjacent units so heat cannot transfer due to direct contact.
- Use a cabinet fan or other enclosure cooling technique.

- Minimize the rate or frequency of your wireless communications. Simply polling or reporting too frequently can cause the temperature of the unit to increase significantly.

Note: Some models allow you to monitor the internal temperature of the cellular modem inside. For best performance, this internal temperature should be kept below 85°C. Refer to the Software Manual for details.

Cold Operating Conditions

These units will operate down to -40°C when properly installed in an enclosure that protects them from direct exposure to the elements. These units are not rated for outdoor installation without protection. Please note that when operating below -30°C some reduction in the wireless performance may occur.

Cleaning

Clean only with a damp cloth. Excess moisture or harsh chemicals can cause damage to the unit.





Service and Support Information

Service Information

We sincerely hope that you never experience a problem with any Red Lion product. If you do need service, call Red Lion at 1-877-432-9908 for Technical Support. A trained specialist will help you quickly determine the source of the problem. Many problems are easily resolved with a single phone call. If it is necessary to return a unit to us, an RO (Repair Order) can be obtained on the [Red Lion website](#).

Red Lion tracks the flow of returned material with our RO system to ensure speedy service. You must include this RO number on the outside of the box so that your return can be processed immediately.

Be sure to have your original purchase order number and date purchased available.

We suggest that you give us a repair purchase order number in case the repair is not covered under our warranty. You will not be billed if the repair is covered under warranty.

Please supply us with as many details about the problem as you can. The information you supply will be written on the RO form and supplied to the repair department before your unit arrives. This helps us to provide you with the best service, in the fastest manner. Repairs are completed as soon as possible. If you need a quicker turnaround, ship the unit to us by air freight. We give priority service to equipment that arrives by overnight delivery.

We apologize for any inconvenience that the need for repair may cause you. We hope that our rapid service meets your needs. If you have any suggestions to help us improve our service, please give us a call. We appreciate your ideas and will respond to them.

For Your Convenience:

Please fill in the following and keep this manual with your Red Lion system for future reference:

P.O. #: _____ Date Purchased: _____

Purchased From: _____

Product Support

Technical Support:

Phone: +1 877 432-9908

Fax: +1 717 764-0839

E-mail: support@redlion.net

Hours: 8:00 am to 5:00 pm EST



Sales Support :

USAT | Connect What's Critical
605 Eastowne Drive, Chapel Hill, NC 27514

Phone: (888) 550-8728

Email: info@usatcorp.com

Web: <https://usatcorp.com>

