



**EL228**  
**Industrial Ethernet**  
**Managed Switch**

# **Installation Guide**

Revision: 24 April 2015

[www.redlion.net](http://www.redlion.net)

This page intentionally left blank.

# Installation Guide

## Industrial Ethernet Switch

Layer 2 with 24 + 4G:

- 24 100BASE-BX (SFP) Ports
- 2 1000BASE-T (RJ45) Ports
- 2 Combination Gigabit (RJ45/SFP) Ports



Included with the switch (typically):

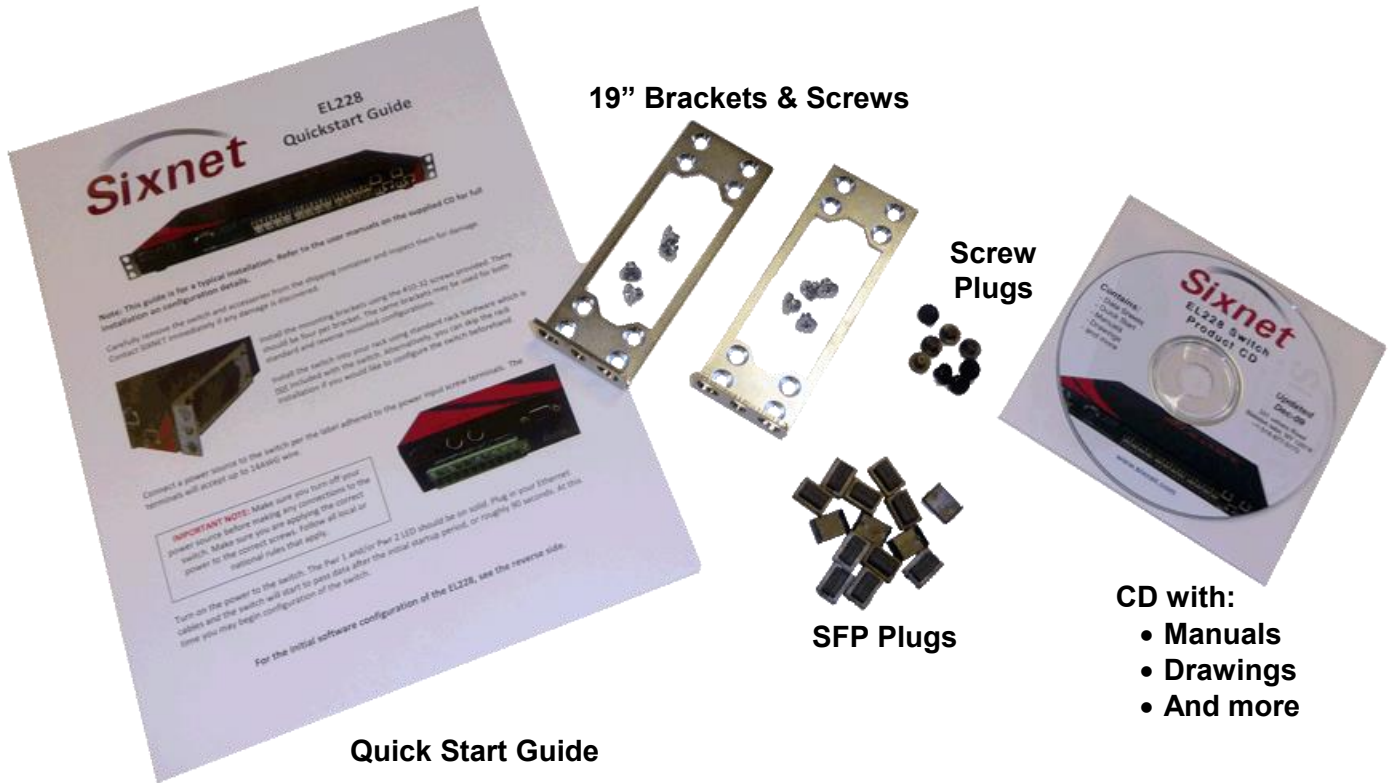

# About This Guide

## Purpose

This guide gives specific information on how to properly install and maintain the switch.

## Audience

The guide is intended for use by network administrators who are responsible for installing and setting up network equipment; consequently, it assumes a basic working knowledge of electrical safety and any local, regulatory or corporate rules for the installation of industrial electrical equipment.

## Conventions

The following conventions are used throughout this guide to show information:

**Note or Notice:** Emphasizes important information or calls your attention to related features or instructions.

**Caution, risk of danger:** Alerts you to a potential hazard that could cause loss of data, or damage the system or equipment. Documentation must be consulted in all cases where this symbol is marked.



Typical caution symbol.

**Warning, risk of electrical shock:** Alerts you to a potential hazard that could cause personal injury.



Typical warning symbol.

## Related Publications

The following publication details the software features of the switch, including the Web interface, CLI and much more:

### ***EL228 Management Guide***

Also, as part of the switch's software, there is an online web-based help that describes all management related features.

## Revision History

First release.

## Copyright & Trademarks

Copyright ©2013 Sixnet Inc. All Rights Reserved.

**Note: All information in this document is subject to change without notice.**

# Compliance and Safety Information

## Installation Warnings



Please read the following safety information carefully before installing or performing any maintenance on the switch. These products are suitable for use in Class I, Division 2, Groups A, B, C and D hazardous locations or nonhazardous locations only.

Note: Only the EL228-DD-1 and the EL228-D0-1 are approved for Zone 2 (ATEX) areas.

- **Warning:** These products should not be used to replace proper safety interlocking. No software-based device (or any other solid-state device) should ever be designed to be responsible for the maintenance of consequential equipment or personnel safety. In particular, disclaims any responsibility for damages, either direct or consequential, that result from the use of this equipment in any application. All power, input and output (I/O) wiring must be in accordance with Class I, Division 2 wiring methods and/or in accordance with the authority having jurisdiction. Refer to section 1 for other important installation warnings.
- **Warning:** Installation, maintenance and removal of the switch must be carried out by qualified personnel only.
- **Warning:** Install the Managed Switches in accordance with local and national electrical codes.
- **Warning:** The unit must be properly grounded to comply with international standards.
- **Warning:** Do not connect to an AC power supply without an earth ground.
- **Warning:** This product does not contain any user serviceable parts.
- **Warning:** Do not work on equipment during periods of lightning activity.
- **Warning:** Do not connect a telephone line into one of the Ethernet RJ45 connectors.
- **Warning:** Exposure to some chemicals may degrade the sealing properties of the materials used in the Sealed Relay Device.
- **Warning (explosion hazard):** Substitution of any component may impair suitability for Class I, Division 2 and Zone 2 areas.
- **Warning (ATEX):** These products are to be used within locking control panels or rack enclosures in hazardous locations. The enclosure shall be suitable for this location. A minimum IP54 rated enclosure is needed for Zone 2 (ATEX) unless an equivalent degree of protection is supplied by the location.
- **Warning (explosion hazard):** When in hazardous locations, disconnect power before servicing units.
- **Warning (explosion hazard):** Do not disconnect equipment while the circuit is live or unless the area is known to be free of ignitable concentrations.
- **Warning (explosion hazard):** In hazardous or potentially hazardous locations, do not separate any part of unit when energized. Use the unit for internal connections only.
- **Warning (explosion hazard):** No hot swapping of modules in Hazardous Locations.

# CAUTIONS POUR INSTALLATION



S'il vous plaît lire attentivement les consignes de sécurité suivantes avant d'installer ou d'effectuer un entretien sur l'appareil. Cet appareil est adapté pour utilisation de Classe I, Division 2, Groupes A, B, C, D endroits dangereux ou endroits non-dangereux.

**Note:** *Seulement les EL228-DD-1 et EL228-D0-1 sont approuvés pour les endroits Zone 2 (ATEX).*

- **Avertissement:** Ces produits ne doivent pas être utilisés pour remplacer le verrouillage de sécurité approprié. Aucun dispositif basé sur un logiciel (ou tout autre dispositif à l'état solide) devraient jamais être conçus pour être responsable de l'entretien de l'équipement consécutifs ou la sécurité du personnel. En particulier, Red Lion décline toute responsabilité pour les dommages, directs ou indirects, résultant de l'utilisation de cet équipement dans n'importe quelle application. Tout courant, câblage entrée et sortie (I / O) doit être conforme aux méthodes de câblage à la Classe I, Division 2 et conformément à l'autorité compétente. Référez à la section 1 pour les autres avertissements d'installation importante.
- **Avertissement:** Installation, entretien et l'enlèvement de l'interrupteur doivent être effectués par du personnel qualifié.
- **Avertissement:** Installez les Commutateurs Gérés conformément aux codes électriques locaux et nationaux.
- **Avertissement:** L'appareil doit être correctement mis à la terre afin de se conformer aux normes internationales.
- **Avertissement:** Ne pas se connecter à une source d'alimentation CA sans une prise de terre.
- **Avertissement:** Ce produit ne contient pas de pièces réparables par l'utilisateur.
- **Avertissement:** Ne pas travailler sur le matériel pendant les périodes d'activités de la foudre.
- **Avertissement:** Ne branchez pas une ligne téléphonique dans l'un des connecteurs RJ45 Ethernet.
- **Avertissement:** L'exposition à certains produits chimiques peut dégrader les propriétés d'étanchéité des matériaux utilisés dans les relais étanche périphérique.
- **Avertissement (risque d'explosion):** La substitution de tout composant peut nuire à la conformité de Classe I, Division 2 (Zone 2).
- **Avertissement (ATEX):** Dans les endroits dangereux, ces produits doivent être utilisés dans des panneaux de commande verrouillés ou dans des étagères clos. L'enclos doit être adapté à cet endroit. Un enclos classé IP54 minimum est nécessaire pour la Zone 2 (ATEX), sauf si un degré de protection équivalent est fourni par l'emplacement.
- **Avertissement (risque d'explosion):** Lorsque dans des endroits dangereux, débranchez le cordon d'alimentation avant de remplacer ou de brancher des modules.
- **Avertissement (risque d'explosion):** Ne débranchez pas l'équipement pendant que le circuit est direct ou à moins que l'environnement soit connu pour être libre de concentrations inflammables.
- **Avertissement (risque d'explosion):** Dans les endroits dangereux ou potentiellement dangereux, ne pas séparer une partie de l'unité sous tension. Seulement utilisez l'appareil pour les connexions internes.
- **Avertissement (risque d'explosion):** Pas de remplacement à chaud des modules dans les zones dangereuses.

## Fiber Optic Safety



**Warning:** When using fiber optic ports, never look at the transmit laser, fiber TX port or fiber cable ends while the switch is powered on. It is highly recommended to keep the rubber fiber plugs inserted when the fiber port is not being used.

## Hi-Pot (Dielectric) Testing



**Caution:** This device is designed to withstand a high-potential “hi-pot” (dielectric) test up to 2000 VAC or 2800 VDC (1 minute), or 2400 VAC or 3300 VDC (1 second) according to IEEE 1613. However, the surge circuitry must be bypassed before performing this test. See section 8 for details.

	<p><b>Power Markings</b></p> <p> Direct Current (DC)</p> <p> Alternating Current</p> <p> Protective Conductor Terminal</p>
--	---

## FCC Statement

This device complies with Part 15 of the FCC Rules. Operation is subject to the following two conditions:

- This device may not cause harmful interference.
- This device must accept any interference received, including interference that may cause undesired operation.

**Warning:** This equipment has been tested and found to comply with the limits for digital device, pursuant to Part 15 of the FCC Rules. These limits are designed to provide reasonable protection. This equipment generates, uses and can radiate radio frequency energy and, if not installed and used in accordance with the instructions, may cause interference to radio communications. However, there is no guarantee that interference will not occur in a particular installation. If this equipment does cause harmful interference to radio or television reception, which can be determined by turning the equipment off and on, the user is encouraged to try to correct the interference by one or more of the following measures:

- Reorient or relocate the receiving antenna.
- Increase the separation between the equipment and receiver.
- Connect the equipment into an outlet on a circuit different from that to which the receiver is connected.
- Consult the dealer or an experienced radio/TV technician for help.

**Notice:** Shielded interface cable must be used in order to comply with emission limits.

**Notice:** Changes or modification not expressly approved by the party responsible for compliance could void the user's authority to operate the equipment.

## Industry Canada Statement

This device complies with the limits of Industry Canada per ICES-003. Operation is subject to the following two conditions:

- This device may not cause harmful interference, and
- This device must accept any interference received, including interference that may cause undesired operation.
- Ce dispositif peut ne pas causer l'interférence nocive et
- Ce dispositif doit accepter n'importe quelle interférence reçue, y compris l'interférence qui peut causer l'opération peu désirée.



# Warranty Statement

Red Lion, manufacturer of Red Lion products, warrants to Buyer that products, except software, manufactured by Red Lion will be free from defects in material and workmanship. Red Lion's obligation under this warranty will be limited to repairing or replacing, at Red Lion's option, the defective parts within five (5) years of the date of installation, or within 60 months of the date of shipment from the point of manufacture, whichever is sooner. Products may be returned by Buyer only after permission has been obtained from Red Lion. Buyer will prepay all freight charges to return any products to the repair facility designated by Red Lion.

This limited warranty does not cover losses or damages which occur in shipment to or from Buyer or due to improper installation, maintenance, misuse, neglect or any cause other than ordinary commercial or industrial applications. In particular, Red Lion makes no warranties whatsoever with respect to implied warranties of merchantability or fitness for any particular purpose. All such warranties are hereby expressly disclaimed. No oral or written information or advice given by Red Lion or Red Lion's representative shall create a warranty or in any way increase the scope of this warranty.

This limited warranty is in lieu of all other warranties whether oral or written, expressed or implied. Red Lion's liability shall not exceed the price of the individual units, which are the basis of the claim. In no event shall Red Lion be liable for any loss of profits, loss of use of facilities or equipment, or other indirect, incidental or consequential damages.

**Note:** The EL228 switches have no user serviceable parts. Any unauthorized service will void all warranties. In the unfortunate event that service is required please contact Red Lion for further instructions.

## Getting Support

For local support please contact your regional Red Lion office. Otherwise, to get product information or contact Red Lion directly:

- **Latest product info:** <http://www.redlion.net>
- **E-mail:** [support@redlion.net](mailto:support@redlion.net)
- **Phone:** 1-877-432-9908
- **Fax:** 1-518-877-8346
- **Mailing address:** Red Lion Controls, 20 Willow Springs Circle, York, PA 17406, USA

## Products Covered

This manual applies to the following products:

- **EL228** 28-port managed industrial Ethernet rack-mount switch

# Contents

<b>Section 1</b>	<b>General Information</b>	<b>Page 11</b>
<b>Section 2</b>	<b>Installation and Mounting</b>	<b>Page 13</b>
<b>Section 3</b>	<b>Thermal Considerations</b>	<b>Page 17</b>
<b>Section 4</b>	<b>Power and Output Wiring</b>	<b>Page 18</b>
<b>Section 5</b>	<b>Communication Wiring</b>	<b>Page 22</b>
<b>Section 6</b>	<b>LED Indicators</b>	<b>Page 27</b>
<b>Section 7</b>	<b>Reset Button</b>	<b>Page 28</b>
<b>Section 8</b>	<b>Hi-Pot Testing</b>	<b>Page 29</b>
<b>Section 9</b>	<b>Technical Specifications</b>	<b>Page 31</b>
<b>Section 10</b>	<b>Service Information</b>	<b>Page 33</b>

## Section 1

## General Information

### Overview

The Red Lion EL228 is a 28 port (24 + 4G) industrial Ethernet managed switch designed to meet the extreme requirements of power substations, traffic control, railway and other harsh environments. It combines the high performance and security of an enterprise-class switch with rugged packaging and protected circuitry to meet the needs of the most demanding applications.

24 fast Ethernet fiber and copper SFP ports, which can be mixed and matched on the fly, provide the ultimate in port flexibility. Red Lion's universal mounting features LEDs, power/ground connections, console ports and bracket positions on both the front and back of the switch for quick and easy ordering and deployment. By combining all of these features in one hardened package, the EL228 provides users with the lowest total cost of ownership of any industrial Ethernet switch in its class.

This manual will help you install and maintain these industrial Ethernet switches. Installation of these switches is very easy and they will begin to operate as soon as they are powered up. Though these are fully managed switches, they will act as unmanaged until they are configured otherwise. Refer to the separate software manual or management guide for configuration of the advanced networking functionality and security.

**Note:** This manual only covers the installation and wiring of these switches. Refer to the separate **Management Guide** for details on configuring and using any of the management functions such as **SNMP, RSTP, IGMP, VLANs, security, port mirroring and much more.**

### Basic Operation

Unlike an Ethernet hub that broadcasts all messages out all ports, these industrial Ethernet switches will intelligently route Ethernet messages only out the appropriate port. The major benefits of this are increased bandwidth and speed, reduction or elimination of message collisions, and deterministic performance when tied with real-time systems.

These industrial Ethernet switches support 10BaseT (10 Mbps), 100BaseT (100 Mbps) and 100BaseF (100 Mbps) fiber connections on the first 24 ports. This is accomplished by way of pluggable SFP transceivers. The 4 Gigabit ports supports 10/100/1000BaseT (10/100/1000 Mbps) on their RJ45 ports plus 100/1000BaseF (100/1000 mbps fiber) via the two available SFP cages. All of the copper RJ45 ports will independently auto-sense the speed/duplex and mdi/mdix-crossover allowing you to use straight or crossed-wired cables. Fiber optic transceivers are available to make noise-immune multimode and singlemode connections up to 120 km.

### General Specifications

These general specifications apply to these industrial Ethernet switches. Refer to Section 7 for complete technical specifications.

<b>Number of ports</b>	28 Ethernet ports
<b>Ethernet Switch Type</b>	Managed
<b>Ethernet Switch Mode</b>	Store and forward, wire-speed, non-blocking
<b>Ethernet Protocols</b>	All standard IEEE 802.3 protocols supported
<b>Ports 1 through 24</b>	SFP for pluggable transceivers of type 10/100 Mbps copper RJ45 or 100 Mbps fiber optic
<b>Ports 25 and 26</b>	Gigabit combination ports with both RJ45 (10/100/1000) and SFP slots for 100 or 1000 Mbps fiber transceivers
<b>Ports 27 and 28</b>	Gigabit RJ45 ports for 10/100/1000 Mbps connections
<b>RJ45 Ports Operation</b>	Auto-negotiation, auto-mdi/mdix-crossover and auto-polarity
<b>Fiber Optic Type</b>	Multimode, singlemode, long-haul or special application
<b>Package style</b>	1U 19" rack mount

## Compliances



These industrial Ethernet Switches meet the following standards plus others:

### Electrical safety

These devices have been designed to meet the basic safety requirements of the following standards:

- CE per Low Voltage Directive and EN/IEC 61010-1
- UL508 (Industrial control equipment ), ANSI / ISA12.12.01 (Hazardous Locations)
- CSA C22.2 142/213 (per cUL)
- Zone 2 (ATEX), Only EL228-DD-1 and EL228-D0-1 are approved for Zone 2 (ATEX) areas.

### EMC (emissions and immunity)

- CE per the EMC directive
- IEC 61000-6-2: Immunity in industrial environments
- IEC 61000-6-4: Emissions in industrial environments
- FCC part 15 and ICES 003; Class B. See FCC statement on a previous page.
- EN 55022 (CISPR22) Class B
- IEC 61850: EMC immunity, mechanical and climatic conditions in power substations
- IEC/TS 61000-6-5: EMC immunity in power substation environments
- IEEE 1613: EMC and climatic conditions in power substations

### WEEE compliance

These devices comply with the WEEE directive. Do not throw away these devices in the standard trash. Contact Red Lion regarding proper disposal.

### RoHS compliance

These devices comply with the RoHS directive and are considered lead and other hazardous substance free.

## Section 2

## Installation and Mounting

### Overview

These industrial Ethernet switches are designed to be mounted in an industry standard rack or directly to any flat surface. Each switch is supplied with a standard set of 19" (EIA) rack mounting brackets. Optionally, other mounting brackets are available. See the next page for details on utilizing the mounting brackets.

**Important Note:** Make sure to read Section 3 regarding thermal considerations before installing your switch.



The above image shows an EL228 in front style arrangement (ports in front and power in the back) mounted in a typical 19" rack, prior to wiring.



The above image shows an EL228 in reverse/rear style arrangement (ports and power in the back) Mounted in a typical 19" rack, prior to wiring.

**Important Note:** When you are choosing your mounting option make sure to allow enough room to route your Ethernet copper or fiber optic cables. Also, please consult the specifications for your fiber optic cable to make sure you allow for the proper bend radius.



## Mounting Brackets

There are many options for mounting these industrial Ethernet switches. Each switch is supplied with a standard set of 19" rack mounting brackets. Optionally, mounting brackets for 23", 24" and ETSI width racks are available. These mounting brackets universally support the mounting hole spacing per the EIA (1.25"), ETSI (25mm) and WECO (1.00") standards. Refer to the mechanical diagram on the next page for details.



There are eight threaded inserts (see red arrows above) on each side of the switch that allow the brackets to be mounted in numerous positions for the best fit in your rack. The brackets also have extra holes (see blue arrows above) allowing them to be shifted right or left 1/2 inch. Use the supplied screws to mount the bracket in the desired position. Plastic screws are also provided to plug the unused holes. See below for possible mounting positions.



In the image above, the brackets are mounted flush with the front of the switch.



In the image above, the brackets are mounted flush with the back of the switch.



In the image above, the brackets are mounted so the front of the switch is setback 1/2 inch.



In the image above, the brackets are mounted in the middle of the switch to accommodate a centrally located rail.



For the most durable mounting you can use two brackets on each side (as shown in the image above). This is ideal for applications requiring the highest shock and vibration resistance.



Standard 19" bracket  
Part #: EK1-BRCKT-19  
(set of 2)



Optional ETSI bracket  
Part #: EK1-BRCKT-ETSI  
(set of 2)



Optional 23" bracket  
Part #: EK1-BRCKT-23  
(set of 2)



Optional 23/24" bracket  
Part #: EK1-BRCKT-2324  
(set of 2)

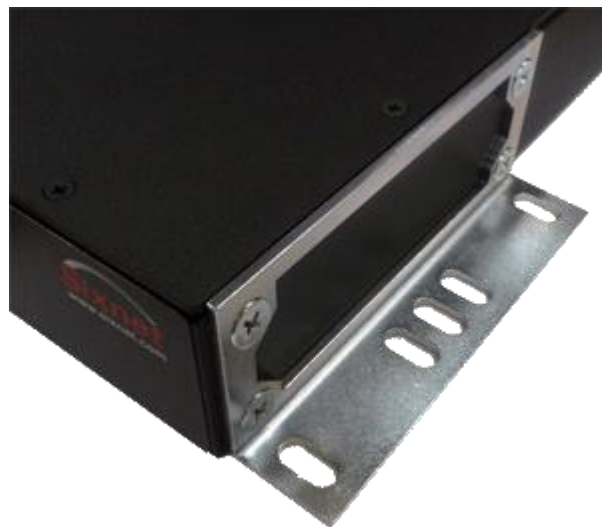

Optional wall bracket  
Part #: EK1-BRCKT-WALL  
(set of 2)

**Note:** AutoCAD and other drawings are available on the CD or at: [www.redlion.net](http://www.redlion.net)

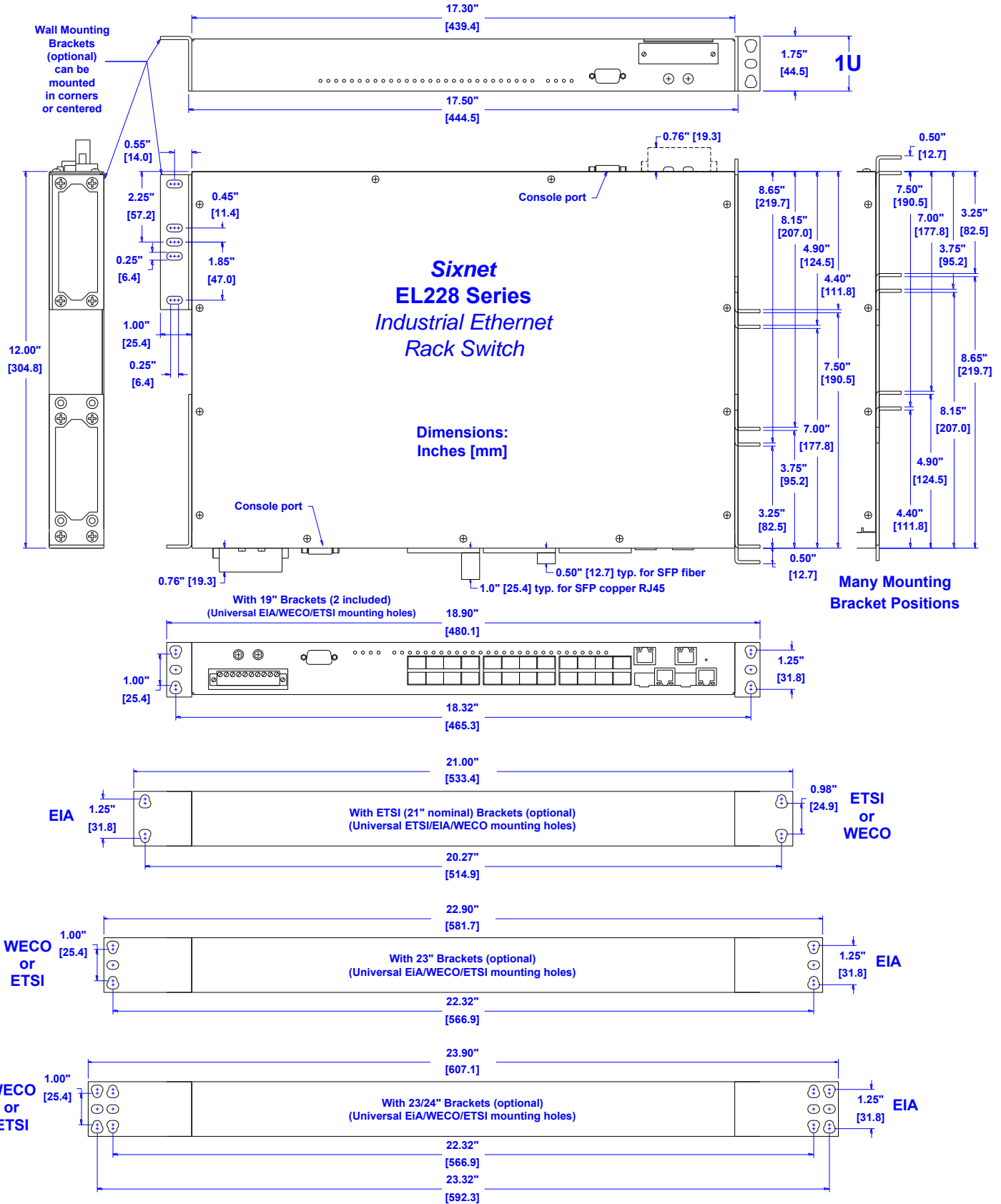

### Mechanical Dimensions for the EL228 and Brackets



## Section 3

# Thermal Considerations

### Overview

The EL228 switches are designed to operate from -40 to +85°C when they are installed properly. The switch is cooled via conduction and radiation. There are no fans. Instead there are various heat-sinks inside the switch to conduct the heat from the components to the heavy-gauge aluminum case. The heat is then dissipated from the case via radiation to the surrounding air.

### Rack Mounting

When the switch is rack mounted, for best heat dissipation it is recommended that there be around 1/2U or more of free air space above and below the switch (as shown below). This allows the heat to radiate to the air. Any moving air in your rack will improve on the cooling of the switch.

**Note:** An air gap is not absolutely necessary but highly recommended when you know that the switch will experience high heat (> 60°C) for extended periods of time.

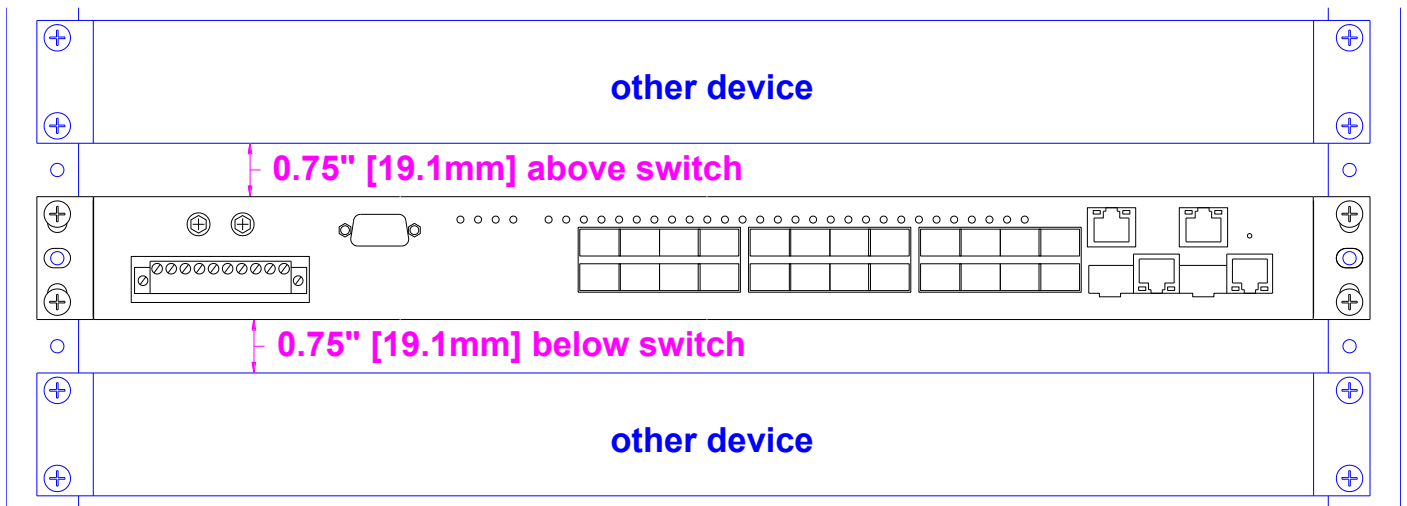

## EL228 Rack Mounting Recommendation

**Suggestion:** If your space is limited and you must choose between an air gap on the bottom versus an air gap on the top it is better to have the air gap on the top.

### BTU / Hour

The power consumption of the switch can be as much as 60 Watts with all ports linked and active. Based on this, the heat dissipation can be as much as 204 BTU per hour. Please plan your system accordingly.

## Section 4

# Power and Output Wiring



### Power Overview

**Warning:** Please read this section fully before connecting your power input or alarm output! The unit must be powered down and the power plug removed before any wiring is done to the power plug. Otherwise, there is a risk of electrical shock if the rules and warnings in this manual are not properly adhered to.

The EL228 switches are offered with several power options including dual power supplies that can keep the switch running when there is a power input failure or internal power supply failure.

#### Standard Power Supply Options:

**Option A0** = single 100/240 (50/60 Hz)VAC or 110/250 VDC power – P1 accepts 85-264 VAC or 90 to 300 VDC (min/max)

**Option AA** = dual 100/240 (50/60 Hz) VAC or 110/250 VDC power – P1 & P2 accept 85-264 VAC or 90 to 300 VDC (min/max)

**Option D0** = single +/-24/48VDC power inputs – P1 accepts +/-18 to 75 VDC (min/max)

**Option DD** = dual +/-24/48VDC power inputs – both P1 & P2 accept +/-18 to 75 VDC (min/max)

#### Note:

With the dual options the two power supplies are completely isolated so each input/supply can be connected to a different voltage as long as it is in the range for that supply.

### Redundancy Operation

The AA and DD power supply options offer dual redundant power supplies built into the switch. This protects your system from both power input failures and internal power supply failures.

**AA Operation:** The AA option provides dual high voltage power inputs. These inputs are load shared so each input shares around 50% of the load under normal operating conditions. If a power input or supply fails then the other one will handle 100% of the load.

**DD Operation:** The DD option provides dual low voltage power inputs. These inputs are load shared so each input shares around 50% of the load under normal operating conditions. If a power input or supply fails then the other one will handle 100% of the load.



**Caution:** Make sure that you know what type of power your switch accepts and make sure that your input power is within the ranges as defined above. Otherwise, you may damage your switch by applying the wrong power.

## Universal Mounting

The EL228 features Universal Mounting (Patent Pending) that allows the power to be connected to either the front or the back of the switch. The EL228 has power input headers on both sides, and is supplied with one power plug (typically pre-installed on the port side) and one power cover (installed on the opposite side).

To move the power plug to the other side, first make sure that all power to the switch is turned off. Then simply unscrew the plug and the power cover. Each is secured with two screws. Then swap the positions of the plug and cover, and reattach both with the aforementioned screws.



**Warning:** There is a risk of electrical shock if the power plug and cover are not properly in place. Make sure to reinstall the power plug and power cover (on the side opposite the power plug) before turning on any power to the switch. Otherwise, when you energize the switch there could be exposed power pins with potentially high voltage.



Power Cover and Ground Plug Screws



Power Plug and Grounding Screws

## Safety Grounding

For the highest electrical safety the EL228 switches are provided with several grounding points. First, there are two green ground screws (see images) that attach directly to the switch case. They are supplied pre-installed on one side of the switch but they can be moved to the other side as desired.

These screws can be used to provide a NEBS compliant safety ground. Please follow all the NEBS grounding rules and your own local requirements (which are not documented in this manual) to ensure the safe operation of the switch. Alternatively, the power plug has a chassis ground terminal (#4) that can be used to safety ground the switch. This terminal is internally tied to the switch case. In addition, there is a ground terminal for each power input. Use these to terminate the ground wire for each of your power inputs.

**Note:** The 2 Safety Guard Screws are designed to be used with Ring Lug Terminals. Do not wrap ground wire around either of the safety ground screws.

**Warning:** It is recommended that you make your safety ground connections first before connecting any power to the switch. Make sure that all power is off before making any power or ground connections to the switch.



### Two #10-32 Screws for NEBS Compliant Safety Grounding

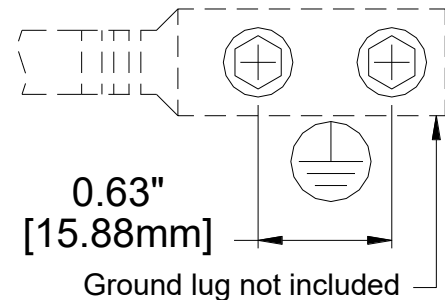

## Power Labeling

The power headers and plugs will be labeled to guide you in properly connecting your power. Make sure to reference this labeling when wiring your switch to make sure you are connecting the appropriate power to the correct terminals. If your switch does not have dual power inputs then do not connect anything to the terminals labeled Power 2.

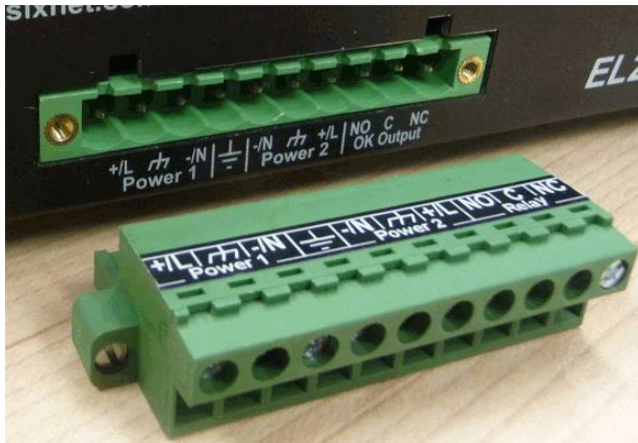

Power Header and Plug Labeling



Power Plug Installed

## Pluggable Screw Block

1 2 3 4 5 6 7 8 9 10

Accepts  
14-24 AWG  
Wire

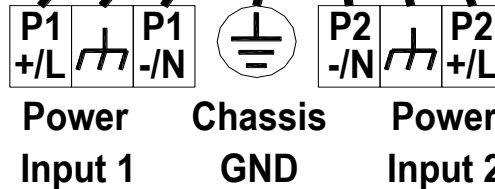
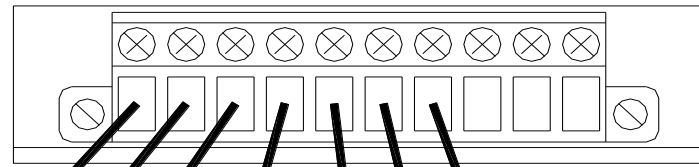

## Power Wiring for EL228 Switches

### AC Power Systems

For AC powered systems the terminals will be labeled as “+/L” for Line (aka Hot), “-/N” for Neutral and the chassis ground symbol for ground. Connect your AC power input as correspondingly. Typically the Line (Hot) lead is colored black or brown, the Neutral lead is colored white or blue and the ground is green or green/yellow.

### Positive (+) DC Power Systems

For positive power systems (such as +24 VDC) put the positive lead on the terminal marked “+/L” and the return (or ground) lead on the terminal marked “-/N”. If there is a chassis, earth or safety ground lead then put it on the associated terminal marked with the chassis ground symbol.

### Negative (-) DC Power Systems

Both the power option “A” and “D” support negative power systems. If your power is negative (such as -48 VDC) then you must put the most positive lead on the “+/L” terminal. Always use a voltmeter to verify which lead is more positive. Then put the more negative lead on the “-/N” terminal. If there is a chassis, earth or safety ground lead then put it on the associated terminal marked with the chassis ground symbol.

### Reverse Polarity Protection

The “D” option power inputs are reverse polarity protected. This means that if you swap the + and – leads then the switch will not be damaged. However, the switch will not operate when wired this way.

## “OK” Alarm Output

The switches have an “OK” alarm output that can be tied to a PLC input, an alarm indicator (visible or audible) or other device to indicate when there is an alarm condition (such as the loss of a power input). The alarm output is a Form C relay with a normally open (NO), normally closed (NC) and common (C) screw terminal. Apply an appropriate power source to the common (C) terminal.

### Alarm Output Ratings:

Maximum voltage = 250 VAC or 30 VDC

Maximum current = 2 A @ 30 VDC 250 VAC

Minimum load = 10 mVDC, 10  $\mu$ A

The relay will operate as follows:

Condition	NO Contact	NC Contact
No power to switch	Closed (shorted to common)	Open
Switch powered with no alarms	Open	Closed (shorted to common)
Switch powered with an alarm	Closed (shorted to common)	Open

## Alarm Wiring for EL228 Switches

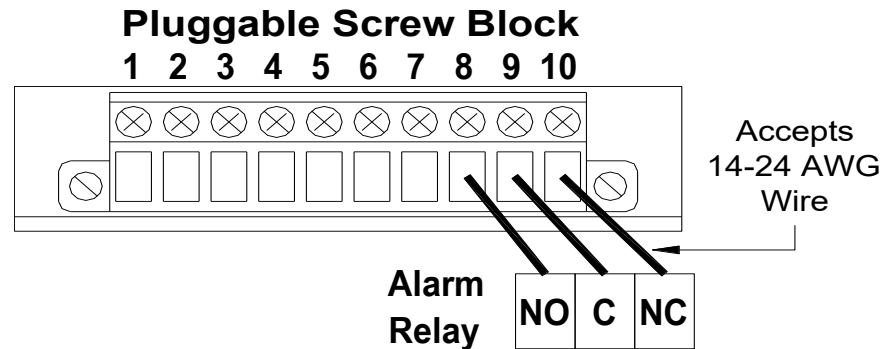

## Wire Gauge & Screw Torque

The screw terminals are removable and secured by two screws. They will accept wire in the range of 24 to 14 AWG. When tightening the screws be careful to tighten to a maximum torque of 4.5 in/lb (0.51 Nm). We recommend a minimum of 18 AWG for the input power wires.



## Section 5

# Communication Ports Wiring

### Overview

The EL228 switches provide connections to standard Ethernet devices such as PLCs, Ethernet I/O, industrial computers and much more. Three types of communication ports may be found on these switches: RJ45 (copper) Ethernet ports, SFP (pluggable) Ethernet ports and console (serial RS232) ports.

### Gig RJ45 Ports 25-28

The EL228 has four Gigabit RJ45 copper ports (25-28) that accept 10/100/1000 Mbps twisted pair cabling. Use data-quality (not voice-quality) twisted pair cable rated category 5E (or better) with standard RJ45 connectors. Straight through or crossover RJ45 cable can be used regardless of the device the switch is to be connected to as all the ports are capable of auto-mdi/mdix-crossover detection.



The RJ45 Ethernet port connector bodies on these products are metallic and are connected to the Chassis GND terminal. Therefore, shielded cables should be used to provide further protection from electrical noise and interference. Ideally, to prevent ground loops, the cable shield should be tied to the metal connector body at one end of the cable only. Electrical isolation is also provided on the Ethernet ports for increased reliability.

**Note:** The use of shielded cables is required to fully meet the requirements of IEC 61850 and IEEE 1613 standards.

For Reference  
Only.  
Either cable  
wiring will work!

Straight-thru Cable Wiring	
Pin 1	Pin 1
Pin 2	Pin 2
Pin 3	Pin 3
Pin 6	Pin 6

Cross-over Cable Wiring	
Pin 1	Pin 3
Pin 2	Pin 6
Pin 3	Pin 1
Pin 6	Pin 2

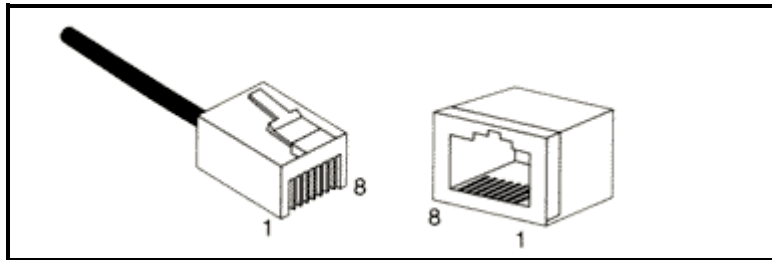

**Ethernet Plug & Connector Pin Positions**

**RJ45 Cable Distance**

The maximum cable length for 10/100/1000BaseT is typically 100 meters (328 ft.).

**Gig SFP Ports 25-26**

Ports 25 and 26 are combination gigabit ports that provide both RJ45 and SFP (Small Form-factor Pluggable) connectors. This allows you to use the RJ45 connectors for twisted pair copper connections or use the SFP connectors for fiber optic connections. The SFP connectors support 100 Mbps and 1000 Mbps fiber optic transceivers for links up to 120 Km.



**Note:** For each of these ports (25 and 26) you can only use one of the connectors (RJ45 or SFP) at a time. If you connect to both at the same time then neither connector may work.

**Fast SFP Ports 1-14**

Ports 1 through 24 offer flexible SFP (Small Form-factor Pluggable) connectors that support 10/100 Mbps RJ45 copper or 100 Mbps fiber optic SFP transceivers. On these 24 ports you can mix and match copper and fiber as desired.



**Typical SFP Transceivers**

The SFP transceivers just plug into the SFP cages. To lock them in place lift the locking arm as shown in the image above. To remove a transceiver, first pull down on the locking/release arm and then pull the transceiver out. The transceivers are “hot-swappable” meaning they can be plugged in or removed when the switch is powered.



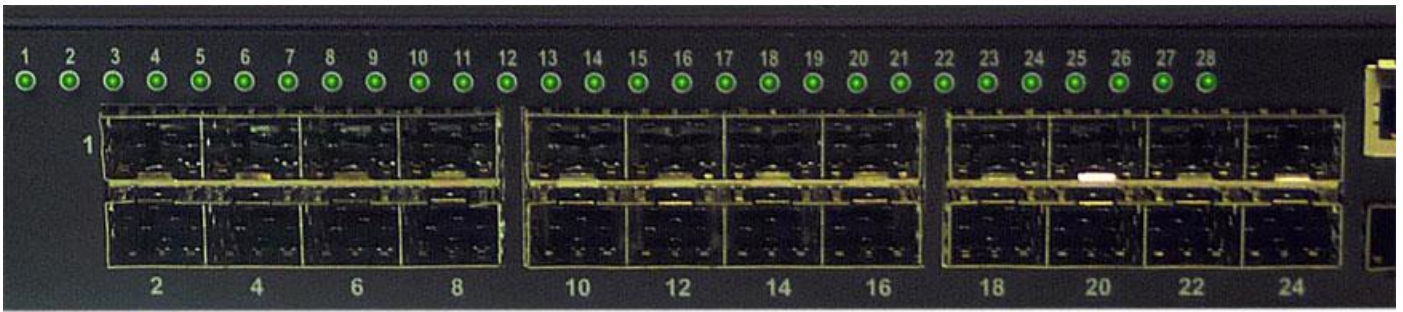

**SFP Ports 1 – 24 with No Transceivers Populated**

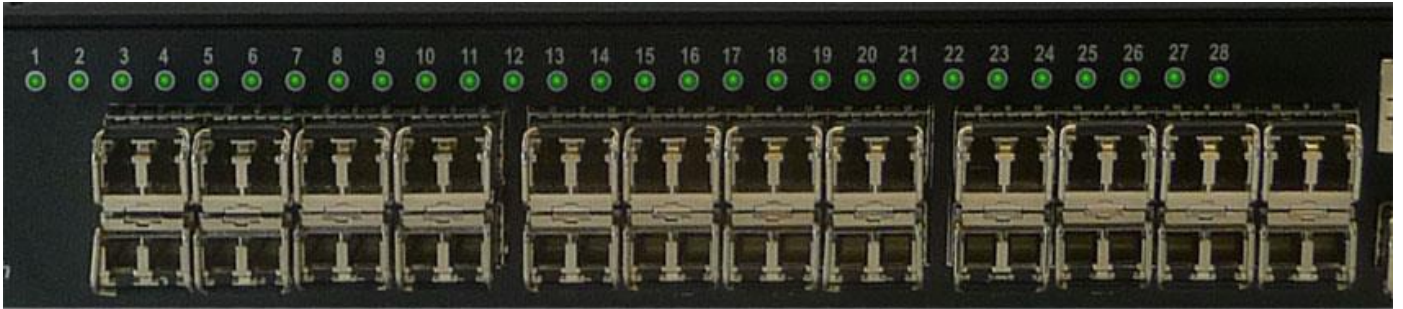

**SFP Ports 1 – 24 with All Fiber Transceivers Populated**



**Mix and Match SFP Transceivers as Desired  
(use supplied plugs to cap unused ports)**

## Fiber Wiring Guidelines

The SFP ports accept fiber optic SFP transceivers. These transceivers are sold separately and are available as multimode, singlemode, long-haul (up to 120 Km or more), BiDi (bidirectional), WDM and other special types. They typically are offered with an LC style fiber connector. Refer to the datasheets for these transceivers for more details.

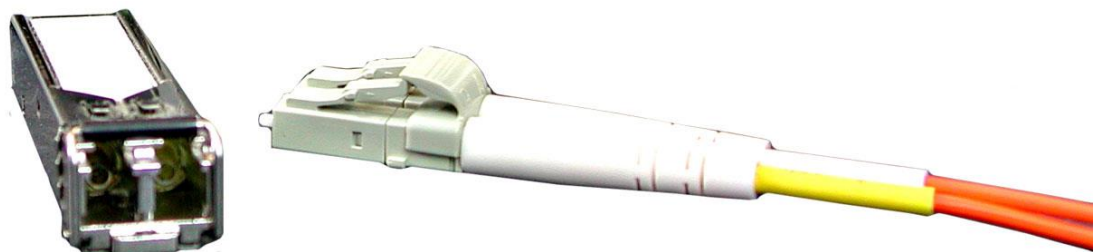

**Typical Fiber SFP Transceiver and Dual-LC Cable**



**Duplex Operation**

**Verifying Connectivity**

**Console Port Management**

Use standard fiber optic wiring techniques (not covered by this manual) to make your connections. The corresponding LED will be ON solid or flashing when you have made a proper connection.

The RJ45 ports will auto-sense for Full or Half duplex operation, while the fiber ports default to full duplex operation or can be configured for Full or Half duplex. Refer to the software user manual for details on the software configuration options.

After all Ethernet and/or fiber connections are made, check the LED's corresponding to the ports that each of the devices are connected to. Ensure that for each port that is in use, the LED is on or blinking. If a port LED is off, go back and check for connectivity problems between that port and the network device connected to that particular port.

The switch can be software configured via the DB9M (DB9 male) RS232 console ports. There is one of these ports located on each of the front and back of the switch. See the images below. This manual only details on how to connect to this port. Refer to the software manual for details on how to configure the switch via this port.

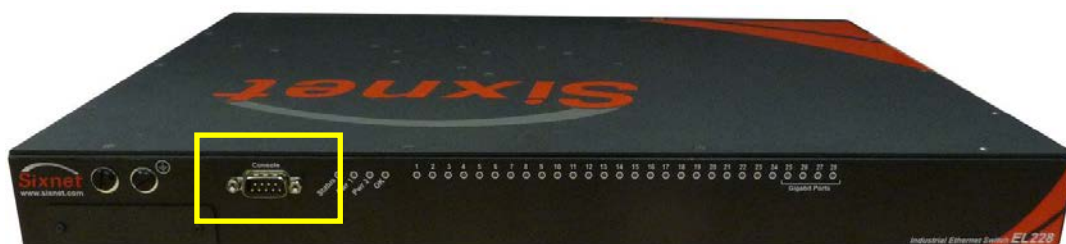

**RS232 DB9M Ports (one on each side)**



**RS232 DB9M Port Closeup**

## Serial DB9 Console Port

The switch has a standard RS232 male DB9 serial port as shown in the previous images. The pin-outs are defined below. Use a standard “null-modem” cable between your PC and the switch. This cable is not supplied but is available from any computer store. If your PC does not have a serial DB9 port then you can purchase an inexpensive USB to Serial converter from any computer store, or use the USB port on the switch.

Switch DB9 Female		Typical Null-modem Cable DB9F to DB9F	PC DB9 Female	
DB9M Pin #	Signal Name		Signal Name	DB9M Pin #
1	CD in		CD in	1
2	RD in		RD in	2
3	TD out		TD out	3
4	DTR out		DTR out	4
5	GND		GND	5
6	DSR in		DSR in	6
7	RTS out		RTS out	7
8	CTS in		CTS in	8
9	RI in		RI in	9

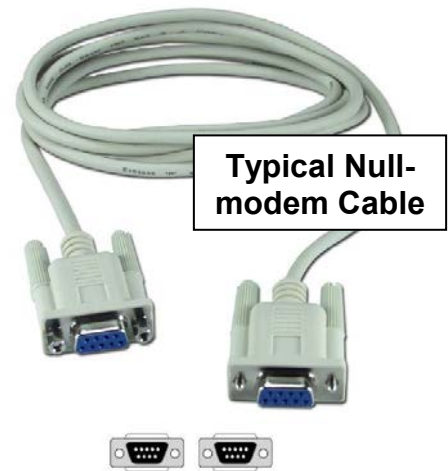

# Section 6

# LED Indicators

## Overview

The EL228 switches have 1 or 2 communication LEDs for each port, dual power LEDs, an “OK” output LED and an overall status LED.

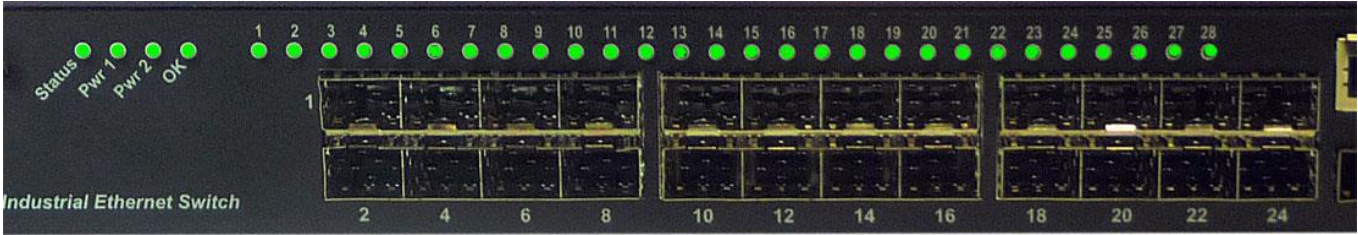

LED Location on Port Side

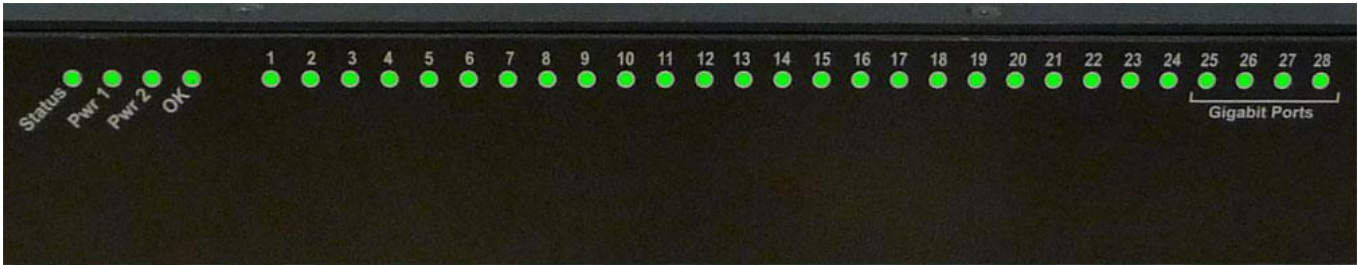

LED Location on Other Side

## All Ports

All 28 ports each have only 1 LED. Regardless of the type of port (RJ45 versus SFP) or type of transceiver the LED behaves as follows:

<b>Green LED ON Solid</b>	<b>Link Only</b> - Indicates that there <u>is</u> a proper Ethernet connection (Link) but no communications activity is detected.
<b>Green LED ON Flashing</b>	<b>Link &amp; Activity</b> - Indicates that there <u>is</u> a proper Ethernet connection (Link) and communications activity is detected.
<b>OFF</b>	<b>No link</b> - Indicates that there <u>is not</u> a proper Ethernet connection (Link). Make sure the cable has been properly connected at both ends.

## Status LED

The Status LED indicates the overall health of the switch. It is normally ON solid indicating that no internal CPU or software problems are detected. It will flash on power up or reset. Otherwise, if it is OFF or flashing for an extended period of time then a problem is detected. In this case, please contact Red Lion for support.

## Power LEDs

There are two Power LEDs (labeled Pwr 1 for primary power and Pwr 2 for backup power) that indicate if there is power applied to the respective input.

## “OK” Alarm LED

The “OK” LED indicates the status of the alarm relay output. This LED will be normally ON when there is no alarm or error condition (such as loss of a power input). Otherwise, when there is an alarm then it will be OFF.

## Section 7

## Reset Button

### Reset Button

A reset button has been provided in the event that a full hardware reset of the switch is required. The reset button is accessed through a small hole in the front of the switch near the status LED. See the image below. Simply use a straightened paper clip to push in the reset button. There is one mode of operation as described below.

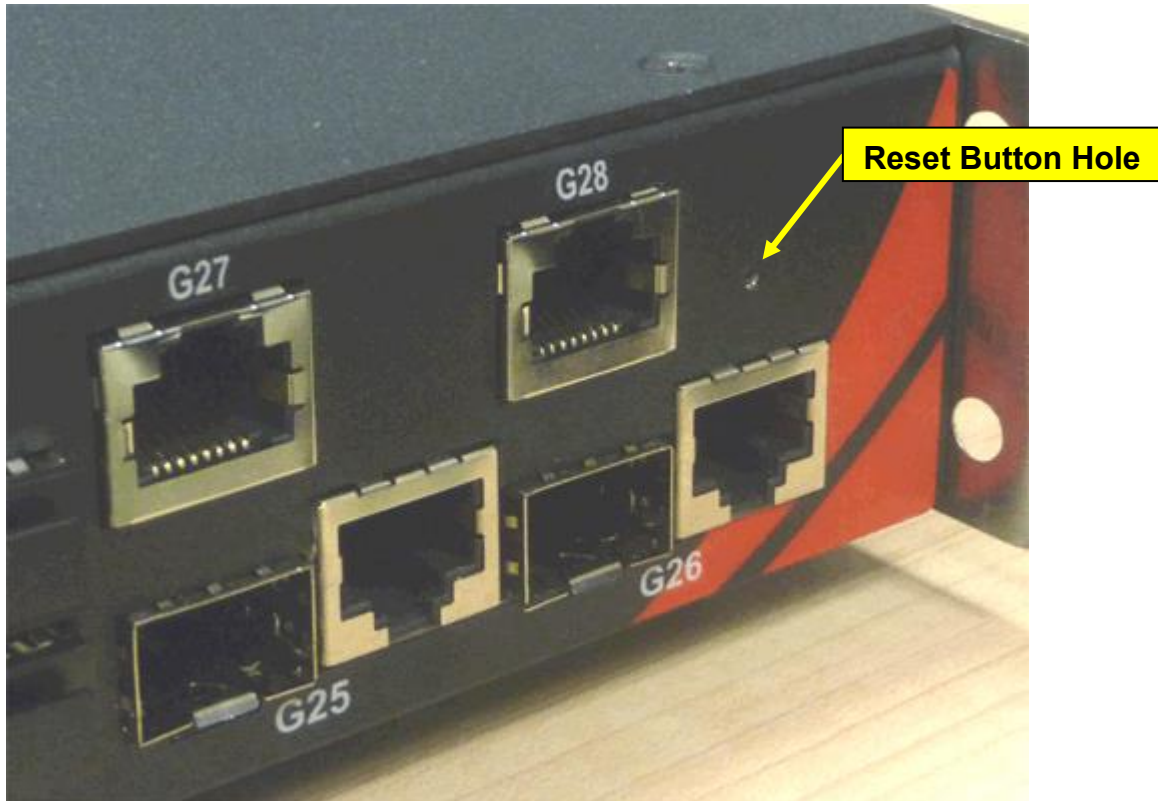

### Hardware Reset

To simply perform a hardware reset just push in the reset button momentarily. The switch will then immediately perform a hardware reset which takes around 2 minutes. The switch will not function or be accessible during this period.



## Section 8

## Hi-Pot Testing

### Hi-Pot Overview



### Hi-Pot Slot

This device is designed to withstand a high-potential “hi-pot” (dielectric) test up to 2000 Vrms according to IEEE 1613. However, the surge protection circuitry must be bypassed before performing this test. See section 8 for details.

**Caution:** The switch’s surge protection circuitry may be damaged if you do not disconnect it while performing a “hi-pot” test.

The switch features a unique method for temporarily disconnecting the surge protection circuitry. An opening in the switch case called the “Hi-Pot Slot” provides for this capability. To perform a Hi-pot test please follow the directions below.



### Hi-Pot Test Step 1

Locate and expose the hi-pot slot. It is found on the side opposite the Ethernet ports. You may need to remove the power plug or power cover.

### Hi-Pot Test Step 2

Acquire or make a hi-pot slot card. You can do this in several ways as follows:

- Contact Red Lion and ask to be sent a complimentary “hi-pot slot card”.
- Use a credit-card-sized plastic card (without raised lettering so not an actual credit card), laminated business card or other similar plastic card. The dimensions should be as shown in the diagram below.
- Cut out a card from 0.02” to 0.03” plastic (such as ABS or polycarbonate). The dimensions should be as shown in the diagram below.

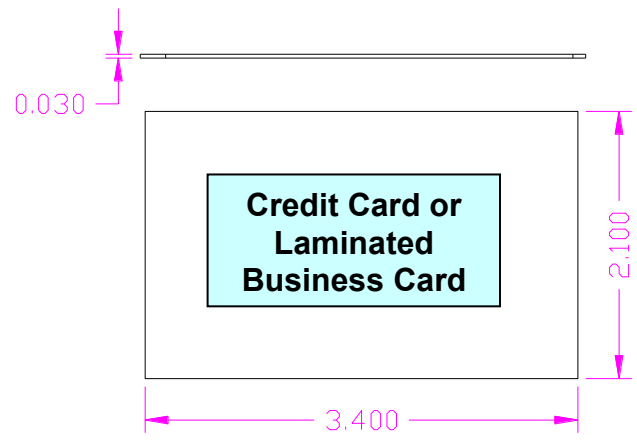
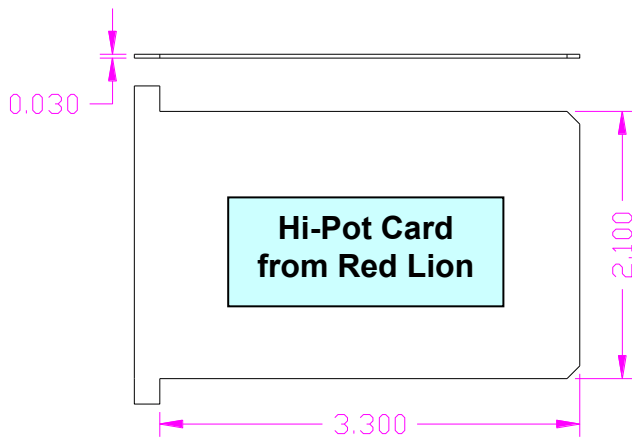

**Recommended Hi-Pot Card Dimensions**

**Hi-Pot Test Step 3**

Insert the card into the slot as shown in the images below. You may need to angle the card up a little to get it started. Once it is started then push the card into the slot perpendicular to the face of the switch. As you push the card in, about half way you should feel some resistance, this is normal. Push the card in until it either stops or there is only about 1/4" left sticking out. See images below.



**Card Fully Inserted**

**Hi-Pot Test Step 4**



With the card in place you can now perform the hi-pot (dielectric) test.

**Caution:** Make sure to remove the card when you are done testing. If you leave the card in place during normal operations then your switch will not be fully protected from surges.

These specifications are subject to change. Contact Red Lion for the latest details. Refer to the software user manual or datasheet for complete software specifications.

**ETHERNET PERFORMANCE**

- 28 total Ethernet ports
- 24 100BASE-X SFP ports
- 4 Gigabit with 2 10/100/1000 RJ45 ports and 2 RJ45/SFP combo ports
- RJ45 ports: auto-negotiation (speed/duplex) and auto-crossover
- Non-blocking, store and forward, wire-speed
- Switching capacity and forwarding rate: 12.8 Gbps / 9.5 Mpps
- MAC address table size: 16K
- Jumbo frame: 10K on Gigabit ports
- Ethernet isolation: 1500 Vrms 1 minute

**SWITCHING FEATURES**

- Flow control: IEEE 802.3x (Full Duplex) & Back-Pressure (Half Duplex)
- Spanning Tree Protocol (STP per IEEE 802.1D) plus
  - IEEE 802.1w Rapid Spanning Tree Protocol (RSTP)
  - IEEE 802.1s Multiple Spanning Tree Protocol (MSTP)
  - BPDU forwarding and filtering
- Real-Time-Ring™ for high speed fault-tolerant rings
  - Link loss recovery: 50 ms/hop
  - Switches in ring: <50 for best performance
  - Multiple rings are supported (up to 4)
- Virtual Local Area Networks (VLANs)
  - 802.1Q tag-based with 256 VLANs and 4K VLAN ID
  - 802.1v protocol and port-based VLAN
  - Voice and Private VLAN
  - QVRP and Q-in-Q (double tagging)
- Link Aggregation Control Protocol (LACP per IEEE 802.3ad)
  - Static trunk (8 trunks and up to 8 ports per trunk)
  - Traffic load balancing
- Internet Group Management Protocol (IGMP)
  - IGMP v1, v2 and v3 with up to 255 multicast groups
  - IGMP snooping and querying
  - Immediate leave and leave proxy
  - Throttling and filtering
- Multicast VLAN Registration (MVR)
- IEEE 802.1ab Link layer Discovery Protocol (LLDP)
- Quality of Service (QoS) with 4 priority queues
  - Scheduling schemes: WRR and Strict priority
  - CoS per IEEE 802.1p and IP DSCP-based
  - DiffServ (DS): ingress, egress and remarking
- Rate limiting (ingress and egress)
  - 64Kbps to 100/1000Mbps
  - Per port CoS

**SECURITY**

- Enable / disable ports
- Port security (MAC-based): static and dynamic
- DHCP Snooping and Option 82
- IP Source Guard
- IEEE 802.1x Network Access Control
  - Port-based with single or multiple host mode
  - Authentication: EAP-MD5, PEAP, TLS, TTLS
  - MAC and web authentication
  - Guest VLAN and Auto VLAN assignment
- RADIUS and TACACS AAA
  - Authentication, Accounting and Authorization
  - 5 servers for RADIUS, 1 server for TACACS
  - Encryption: MD5, TLS, TTLS, TACACS AAA/3.0
- Access Control List (ACL)
  - IP and MAC-based
  - VLAN and TCP/UDP port
- Storm Control for broadcast and multicast messages
- HTTPS/SSL for secure Web access
- SSH v1.5/2.0 for secure Telnet access
- SNMPv3 authentication and encryption
- Username and password authentication
- Management access filtering

**MANAGEMENT AND MONITORING**

- IP Address assignment: Static, DHCP and BOOTP
- CLI (Command Line Interface) via console or Telnet
- Web interface (HTTP/HTTPS/SSL)
- SNMP v1, v2, v3 (Simple Network Management Protocol)
- SNMP Traps for event notification
- RMON (Remote Monitoring): Groups 1, 2, 3 and 9
- sFlow network-wide traffic monitoring
- Dual firmware update system
- Configuration download and upload
- Software upgrade via TFTP
- Port mirroring
- Event / Error / System log
  - Local flash
  - Remote server via system log (Syslog RFC 3164)
  - SMTP (RFC 821) email alarming
- Network Time Protocol for time synchronization
  - NTP (RFC 2030) and NTP (RFC 1305)
- DNS (Domain Name Server) client
- Universal Plug and Play (UPnP)
- IEEE 802.3ah OAM (Operational Administration Maintenance)
- Banner commands

### **POWER INPUT and ALARM OUTPUT**

- Dual-redundant internal power supplies
- 10-pole screw block can be positioned in front or back
- Power input options:
  - +/-24-48 VDC (D option) (**absolute min and max: +/-18-75 VDC**)
  - +/-110 - 250 VDC or 100-240 VAC (50/60 Hz)(A option) (**absolute min and max: +/-90 - 300 VDC or 85-264 VAC**)
- Power consumption:
  - 60 Watts typ. w/ all ports linked
  - 28 Watts with no transceivers
  - Add 1.25 Watts typical per transceiver
- Protection: current overload and reverse polarity
- Alarm output: form-C relay (NO and NC contacts)
  - Max. voltage: 250 VAC, 30 VDC
  - Max. current: 2A @ 30 VDC or 250 VAC

### **MECHANICAL**

- Universal mounting: (Sixnet-exclusive feature – Patent Pending!)
  - Front or rear/reverse wiring with power in front or back
  - 1U rack mount (19" brackets included)
  - Optional 23", 24", EIA, WECO, ETSI and wall brackets available
- Ingress protection: IP50 sealed from dust and contaminants
- Heavy-gauge corrosion-resistant metal enclosure
- Dimensions (HxWxD): 1.75(1U)x17.3x12" (45x439x305mm)
- Weight (typical): 5.5 lbs (2.5 kg)

### **ENVIRONMENTAL**

- Operating/storage temperature: Designed and tested to -40 to +85°C per IEC 60068-2-1/2
- Humidity: 5 to 95% RH (non-condensing) per IEC 60068-2-78
- **Vibration: 20mm/s from 1 to 150 Hz per IEEE 1613 Class V.S.3**
- **Vibration: Amp: 3mm from 2-9 Hz, 1g from 9-200Hz, 1.5g from 200-500 Hz per IEC 61850-3**
- **Shock: 30g @ 11ms per IEC 61850-3**
- Shock - Free Fall: 250mm distance

### **EMC and STANDARDS COMPLIANCE**

- Substation: IEC 61850-3 / IEC 60870-2-2; IEEE 1613
- EMC immunity: IEEE C37.90 and c37.90.1/2/3; IEC/TS 61000-6-5, IEC 60870-2-1, IEC 61000-4 2/3/4/5/6/8/10/11/12/16/17/18/29, IEC 60255-5, CE
- EMC emissions: FCC Part 15; EN 55022 (CISPR22), CE
- **Safety: UL508 / ANSI / ISA12.12.01/CSA C22.2 142/213. EL228-DD-1 and the EL228-D0-1, T4 @ 60C (Ambient); EL228-AA-1 and the EL228-A0-1, T3C @ 60C (Ambient). EN61010-1, Zone 2 (ATEX). Only the EL228-DD-1 and the EL228-D0-1 are approved for Zone 2 (ATEX) areas.**
- RoHS, WEEE and CE compliant
- Warranty: 5 years on design and manufacturing defects
- MTBF A0/D0 models: 208,166 Hours GB @ 40°C per MIL-HNDBK-217F2
- MTBF AA/DD models: 204,345 Hours GB @ 40°C per MIL-HNDBK-217F2



## Section 10

## Service Information

### Service Information

We sincerely hope that you never experience a problem with any Red Lion product. If you do need service, call Red Lion at 1-877-432-9908 for Technical Support. A trained specialist will help you to quickly determine the source of the problem. Many problems are easily resolved with a single phone call. If it is necessary to return a unit to us, an RO (Repair Order) can be obtained on the [Red Lion website](#).

Red Lion tracks the flow of returned material with our RO system to ensure speedy service. You must include this RO number on the outside of the box so that your return can be processed immediately.

Be sure to have your original purchase order number and date purchased available.

We suggest that you give us a repair purchase order number in case the repair is not covered under our warranty. You will not be billed if the repair is covered under warranty.

Please supply us with as many details about the problem as you can. The information you supply will be written on the RO form and supplied to the repair department before your unit arrives. This helps us to provide you with the best service, in the fastest manner. Repairs are completed as soon as possible. If you need a quicker turnaround, ship the unit to us by air freight. We give priority service to equipment that arrives by overnight delivery.

We apologize for any inconvenience that the need for repair may cause you. We hope that our rapid service meets your needs. If you have any suggestions to help us improve our service, please give us a call. We appreciate your ideas and will respond to them.

#### **For Your Convenience:**

Please fill in the following and keep this manual with your Red Lion system for future reference:

P.O. #: \_\_\_\_\_ Date Purchased: \_\_\_\_\_

Purchased From: \_\_\_\_\_

### Product Support

To obtain support for Red Lion products:

**Latest product info:** [www.redlion.net](http://www.redlion.net)

**Phone:** 1-877-432-9908

**Fax:** 1-518-877-8346

**E-mail:** [support@redlion.net](mailto:support@redlion.net)

**Address:** Red Lion, 20 Willow Springs Circle, York, PA 17406

This page intentionally left blank.