



INTEGRA-TR™ WIRELESS MODEM FOR LICENSED SPECTRUM



USER MANUAL
PN 001-4008-100 REV 6
FEBRUARY 2013



INTEGRA-TR™ WIRELESS MODEM FOR LICENSED SPECTRUM



USER MANUAL
PN 001-4008-100 REV 6
FEBRUARY 2013

REVISION HISTORY

- Rev 0 June 2011
Initial Release.
- Rev 1 August 2011
Changed Dual Band references to Dual IF, sections 1.6 and 1.8.
Deleted Synthesizer reference, section 4.3.1.3.
- Rev 2 January 2012
Added VHF Dual Band specifications and part numbers, splinter channel frequencies and FCC/IC indicators.
- Rev 3 April 2012
Corrected part numbers in section 1.6.
- Rev 4 September 2012
Updated VHF model numbers, FCC and IC Emission Designators.
- Rev 5 November 2012
Added the 12.5/6.25 kHz bandwidths for the UHF Integra.
- Rev 6 February 2013
Corrected errors in Table 4 regarding the 2424048351 and 2424048551 Models.
Change the UHF RF Exposure Compliance Requirements table

Important Notices

Because of the nature of wireless communication, transmission and reception of data can never be guaranteed. Data may be delayed, corrupted (i.e., have errors), or be totally lost. Significant delays or losses of data are rare when wireless devices such as the Integra-TR are used in a normal manner with a well-constructed network. Integra-TR should not be used in situations where failure to transmit or receive data could result in damage of any kind to the user or any other party, including but not limited to personal injury, death, or loss of property. CalAmp accepts no responsibility for damages of any kind resulting from delays or errors in data transmitted or received using Integra-TR, or for the failure of Integra-TR to transmit or receive such data.

This document provides the information required for the operation and preventive maintenance of the Integra-TR integrated wireless modem. This manual is intended for system designers, installers and maintenance technicians. The Field Programming Software for the Integra is the professional service installer interface. The Field Programming Software should never be made available to unqualified personnel.

Copyright Notice

© 2011 CalAmp Corp. All rights reserved.

Products offered may contain software proprietary to CalAmp. The offer of supply of these products and services does not include or infer any transfer of ownership. No part of the documentation or information supplied may be divulged to any third party without the express written consent of CalAmp. CalAmp reserves the right to update its products, software, or documentation without obligation to notify any individual or entity. Product updates may result in differences between the information provided in this manual and the product shipped.

RF Exposure Compliance Requirements



The Integra-TR radio is intended for use in the Industrial Monitoring and Control and SCADA markets. The Integra-TR unit must be professionally installed and must ensure a minimum separation distance listed in the table below between the radiating structure and any person. An antenna mounted on a pole or tower is the typical installation and in rare instances, a 1/2-wave whip antenna is used.

Min Safety Distance (cm @max power)	Antenna Gain		
	5 dBi	10 dBi	15 dBi
VHF	79.3 cm	141.0 cm	250.8 cm
UHF	74.8 cm	133 cm	236.4 cm
900 MHz	45.0 cm	80.1 cm	142.5 cm

It is the responsibility of the user to guarantee compliance with the FCC MPE regulations when operating this device in a way other than described above.

Integra-TR uses a low power radio frequency transmitter. The concentrated energy from an antenna may pose a health hazard. People should not be in front of the antenna when the transmitter is operating.

The installer of this equipment must ensure the antenna is located or pointed such that it does not emit an RF field in excess of Health Canada limits for the general population. Recommended safety guidelines for the human exposure to radio frequency electromagnetic energy are contained in the Canadian Safety Code 6 (available from Health Canada) and the Federal Communications Commission (FCC) Bulletin 65.

Any changes or modifications not expressly approved by the party responsible for compliance (in the country where used) could void the user's authority to operate the equipment.

Table of Contents

1	PRODUCT OVERVIEW.....	6
1.1	General Description	6
1.2	Operational Characteristics	6
1.3	Physical Description	7
1.4	Front Panel.....	7
1.4.1	Antenna Connector	7
1.4.2	LED Indicators	7
1.4.3	COM Port	8
1.4.4	Setup Port	9
1.5	Rear Panel.....	9
1.5.1	Heat Sink	10
1.5.2	Power – I/O Connector	10
1.6	Part Number Breakdown	10
1.6.1	Transceiver Identification	11
1.7	Accessories and Options	11
1.8	Specifications	12
2	Getting Started	14
2.1	Device Connections.....	14
2.2	Field Programming Software	14
2.2.1	Installing the FPS.....	15
2.2.2	Using the FPS	16
3	Network Applications	17
3.1	RF Path and Communications Range	17
3.2	Common Architectural Characteristics	17
3.2.1	Point-to-Point System	17
3.2.2	Point-to-Multipoint System	18
3.2.3	Extending a Landline (Tail Circuit).....	20
4	Integra-TR Field Programming Software	21
4.1	Integra-TR Programmer Window.....	21
4.2	File Menu	21
4.3	Edit Menu.....	22
4.3.1	Setup Modem/Radio Parameters	23
4.3.2	Version Request	32
4.3.3	List Information.....	33
4.3.4	Apply Integra Reset.....	33
4.3.5	Program Comment/ID.....	33
4.3.6	Program Parameters	34
4.3.7	Read Parameters.....	35
4.3.8	Copy Parameters.....	35
4.4	Utilities Menu	35
4.4.1	Port Settings.....	36
4.4.2	Swap COM Ports	39
4.4.3	Port Statistics	39
4.4.4	Offline Link Test	41
4.4.5	Offline Diagnostics	42
4.4.6	Online Diagnostics	45
4.4.7	Diagnostic IDs and Alarms.....	48
4.4.8	User Test	49
4.4.9	Packet Test.....	51
4.4.10	Array Test.....	53

4.4.11	Ping Test.....	55
4.4.12	ASCII/Hex Terminal	57
4.5	Program Code Menu	59
5	Network Optimization	60
5.1	Choose the best protocol.....	60
5.2	Check timer settings	60
5.3	Avoid flow control.....	60
5.4	Use the highest suitable port baud rate	60
5.5	Evaluate the need for online diagnostics.....	60
5.6	Interpreting RSSI Readings.....	60
5.7	Interpreting Power Readings	61
5.8	swr and Reverse Power.....	61
6	DEFINITIONS	62

1 PRODUCT OVERVIEW

This document provides the information required for the operation and preventive maintenance of the Integra-TR integrated wireless modem. This manual is intended for system designers, installers and maintenance technicians. ***The Field Programming Software for the Integra is the professional service installer interface. The Field Programming Software should never be made available to unqualified personnel.***

1.1 GENERAL DESCRIPTION

Integra-TR is a high-speed transparent integrated wireless modem. It is FCC refarming compliant and designed specifically to fit the needs of SCADA, telemetry and control applications. Integra-TR provides the communication links to data equipment for installations where wired communication is impractical.

Integra-TR works with most makes and models of remote terminal units (RTU) and programmable logic controllers (PLC) and their protocols. Configuration settings allow tailoring for a variety of applications. Integra-TR supports:

- Point to point Master-Remote or Peer-to-Peer configurations in simplex or half-duplex modes.
- Point to multipoint Master-Remote configuration in simplex or half-duplex modes and offers full-duplex in dual-unit configuration. These configurations are available as I-Base products. Contact your CalAmp Representative for details.

1.2 OPERATIONAL CHARACTERISTICS

Integra-TR has the following operational characteristics:

- Selectable network speeds of 4800 and 9600 b/s for half channel units as well as 4800, 9600 and 19200 b/s for full channel units
- Backward compatible with the Integra-T for bit rate of 4800 and 9600 b/s (full channel units only)
- One COM port for connection to DTE. Speed of 1200 - 19200 baud
- One Setup port for configuration and diagnostics (speed fixed to 9600 baud, 8 bit, no parity, 1 stop bit)
- Built-in 5-watt transceiver (adjustable 1-5 watts), operating in the VHF, UHF or 900 MHz communications bands. Half-duplex or simplex operation
- Fully transparent operation with error-free data delivery
- Allows transmission of "break" characters
- DOX (Data Operated Transmit) or RTS mode
- Stations may be set as "master" or "remote" to prevent remote stations from hearing each other in a simplex RF configuration
- Full local and remote diagnostics
- Two configurable I/O lines programmable as either 8-bit analog inputs or digital outputs
- 12 VDC, negative ground device
- CWID provides the ability to program the unit to periodically identify itself on the air by sending the FCC Station ID in Morse code
- Disable Tx w/Carrier Present configures the unit to prevent transmission when the radio channel is busy
- Low power consumption modes: "sleep" and "suspend" modes (< 20 mA)
- Multi-channel capability under system PLC control provides advanced network monitoring

1.3 PHYSICAL DESCRIPTION

Integra-TR consists of a logic PCB (which includes modem circuitry) and a radio module. Each logic PCB and radio module are matched together and characterized in the factory to optimize performance as an intelligent unit. The two boards then slide into the rails of an extruded aluminum case.

DTE connection is made via a front panel connector. Power is applied through a rear panel 4-pin connector which includes two programmable analog connections usable as inputs or outputs.

The unit is not hermetically sealed and should be mounted in a suitable enclosure when dust and/or a corrosive atmosphere are anticipated. Physically, there are no external switches or adjustments. All operating parameters are set using the Field Programming Software.

1.4 FRONT PANEL

Integra-TR front panel elements are described in Figure 1 - Integra TR Front Panel Figure 1.

Figure 1 - Integra TR Front Panel



1.4.1 ANTENNA CONNECTOR

Integra-TR antenna connector is a female 50-ohm SMA- type. Units operating with a rubber duck connected directly to the antenna connector may exhibit unusual operating characteristics and high levels of reverse power.

1.4.2 LED INDICATORS

Integra-TR has four two-color LED indicators. Their functions are shown in Table 1. LED indicators may vary during startup.

Table 1 - LEDs

LED	Color	Functions
RUN/PWR	Green	Normal operation
	Flash Yellow and Green	Setup mode or loading new application or new bootloader
	Flash Red	Firmware error (Contact Technical Support)
	Red	CPU or PROM failure (Contact Technical Support)

CS/SYN	Off	No RF RX carrier
	Green	Receive carrier present
	Red	(Reserved)
RX/TX	Off	No RF RX carrier
	Green	Receiving network data
	Yellow	Synthesizer unlocked
	Red	Transmitter is on
RD/TD	Off	Idle
	Green	RX data outgoing from RS-232 port
	Red	TX data incoming at RS-232 port (or Buffered in CSMA Mode)

1.4.3 COM PORT

Integra-TR is configured as DCE. DTE devices should be connected using a nine-conductor pin-to-pin straight cable (PN 697-4008-408). Some RTUs or PLCs may require a special cable to route the signals correctly. Refer to your data equipment documentation package.

DTE baud rates from 1200 to 19200 are supported. Integra-TR's are factory set for or 9600 b/s, 8 bits, no parity, and 1 stop bit. Unless required by your operating protocol, ***we advise restricting port speed to be equal to or less than the RF network speed.***

Table 2 - COM Port Signals

Pin	Name	Function
1	DCD	Output: Always asserted or asserted when receive RF carrier present (selectable via Field Programming Software)
2	RXD	Output: Data from Integra-TR to DTE
3	TXD	Input: Data from DTE to Integra-TR
4	DTR	Input: Ignored
5	GND	Signal and chassis ground
6	DSR	Output: always positive
7	RTS	Input: Used as a "begin transmission" signal in RTS mode
8	CTS	Output: Used for handshaking in RTS mode and used for flow control in DOX mode RTS mode: RTS to CTS delay in 4 ms DOX mode: CTS always asserted except when data overflow is detected
9	RI	Not internally connected, reserved

The DE-9F pin out is shown in Figure 2 for reference.

Figure 2 - COM and Setup Port Connectors Pin Locations

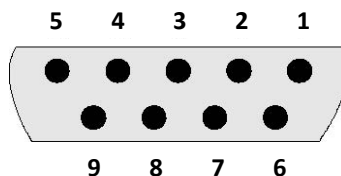

For DTE that lack RTS control, Integra-TR can operate in DOX (Data Operated Transmit) mode with only Transmit Data, Receive Data and Ground. This 3-wire interface is shown in Figure XX.

Figure 3 - 3-wire Interface

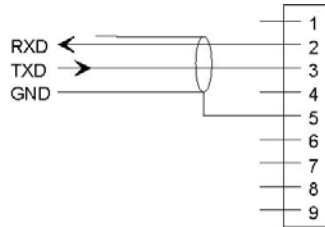

1.4.4 SETUP PORT

The Setup port uses a DE-9 female connector configured as DCE. Signals are described in Table 3.

Table 3 - Setup Port Signals

Pin	Name	Function
1	DCD	Tied directly to DTR
2	RXD	Data from Integra-TR to setup PC
3	TXD	Data from setup PC to Integra-TR
4	DTR	Tied directly to DCD
5	GND	Signal and chassis ground
6	DSR	Output: always positive (asserted)
7	RTS	Tied to CTS
8	CTS	Tied to RTS
9	RI	Not internally connected, reserved

The Setup port uses a proprietary communications protocol designed to work with the Integra-TR Field Programming Software program. It is also designed to provide alpha numeric (ASCII) diagnostics information when connected to a PC terminal emulator.

1.5 REAR PANEL

Figure 4 - Integra-TR Rear Panel

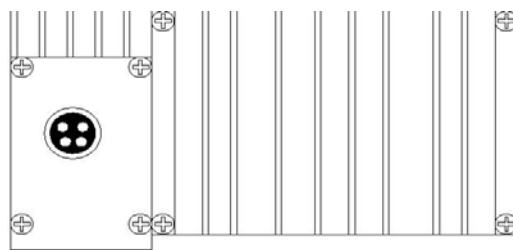

1.5.1 HEAT SINK

The rear panel heat sink is essential for proper operation of the Integra-TR transmitter. The unit must be mounted in a location that permits free air circulation past the heat sink. Cooling will be best if the fins are vertical.

1.5.2 POWER – I/O CONNECTOR

The Integra-TR power requires a regulated power source of 13.3 VDC nominal (10-16 VDC MAX) negative ground with a 3.0 A rating. An internal surface-mount 3A fuse (not field-replaceable) and a crowbar diode protect the main RF power components from reverse polarity. **Application of more than 16 VDC will damage the unit and is not covered by the warranty.**

The 4-pin power/analog connector pin out is shown in Figure 5.

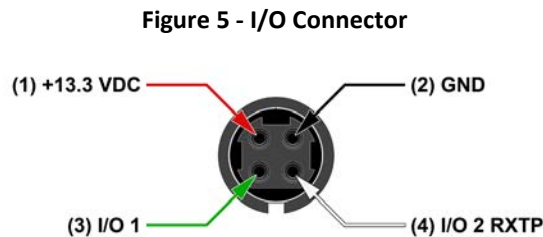

Note: If I/O connections are not used the green and white wires should be cut back and/or taped to prevent contact (power I/O cable part number 697-4008001 see Table 5).

1.6 PART NUMBER BREAKDOWN

The following table provides a breakdown of the Integra-TR part number.

Table 4- Integra-TR Part Number Breakdown

242-40W8-XYZ*				
W	X	Y	Z	
1	VHF	4 136-162 MHz	5	0 Dual IF 12.5 & 25 kHz
		4 136-162 MHz	5	1 Dual IF 6.25 & 12.5 kHz
		5 148-174 MHz	5	0 Dual IF 12.5 & 25 kHz
		5 148-174 MHz	5	1 Dual IF 6.25 & 12.5 kHz
4	UHF	3 406.1-440 MHz (for U.S.)	5	0 Dual IF 12.5 & 25 kHz
		3 406.1-440 MHz (for U.S.)	5	1 Dual IF 6.25 & 12.5 kHz
		5 440-476 MHz (for U.S.)	5	0 Dual IF 12.5 & 25 kHz
		5 440-476 MHz (for U.S.)	5	1 Dual IF 6.25 & 12.5 kHz
		3 406.1-430 MHz (for Canada)	5	0 Dual IF 12.5 & 25 kHz
		3 406.1-430 MHz (for Canada)	5	1 Dual IF 6.25 & 12.5 kHz
		5 450-470 MHz (for Canada)	5	0 Dual IF 12.5 & 25 kHz
		5 450-470 MHz (for Canada)	5	1 Dual IF 6.25 & 12.5 kHz

*An F should follow any part number to designate an Integra-TR with the cooling fan option.

1.6.1 TRANSCEIVER IDENTIFICATION

The transceiver identification is a random, unique serial number (SN) that can be found on the side label of the Integra-TR device. It is also printed on the box label.

1.7 ACCESSORIES AND OPTIONS

Table 5 - Accessories

Part Number	Accessory
250-4008-001	Integra-TR Field Programming Kit includes software, technical manual on CD ROM with programming cable (Part Number 697-4008-408)
697-5000-101	SMA to Type N-Male Adapter Cable
002-4008-100	Start-Up Disc includes Field Programming Software, Manual and Quick Start Guide
Catalog Number + (F)	Factory Installed Cooling Fan
697-4008-001	Power cable
250-0300-133	Switching Power Converter (SPC)
250-0300-175	Demo Power Kit
250-0045-103	Data Interface Kit
250-0005-105	Data Diagnostic Kit
250-5800-408	Integra-TR DIN-rail Mounting Kit
Contact Technical Service	*Full-duplex base station

Figure 6: Integra-TR Mechanical Specifications

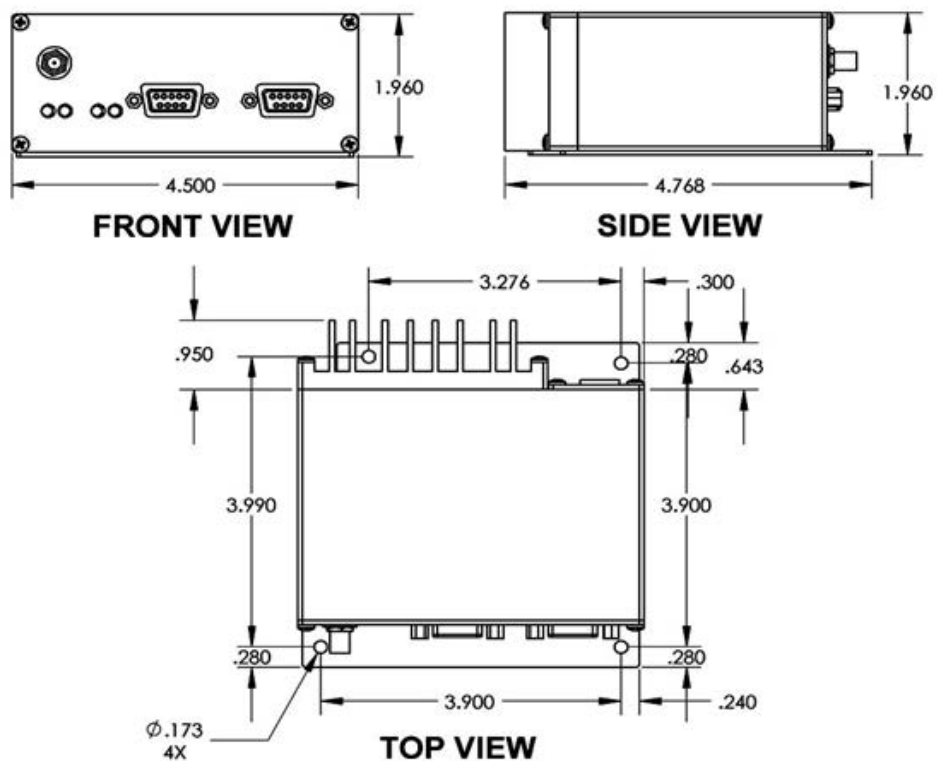

1.8 SPECIFICATIONS

These specifications are subject to change without notice. RF specifications are measured per TIA/EIA-603 with a psophometric baseband filter.

General	
Frequency	VHF 136-174 Dual IF, UHF 406.1-476 MHz Dual IF
Channels	Multi-channel capability under system PLC control
Channel Bandwidth	VHF - 6.25 and 12.5 kHz or 12.5 and 25 kHz (software programmable) UHF - 12.5 and 25 kHz (software programmable)
Operating Temperature	-30° to + 60° C
Supply Voltage	10 - 16 VDC maximum (nominal 13.3) Fuse protected against reverse voltage
RX Current Drain at 13.3 VDC	< 270 mA (with a terminal connected to Integra-TR COM port)
TX Current Drain at 13.3 VDC	<2.6 A
Power Saving Mode Current Drain	<20 mA
Cold Start ¹	4 sec (typical)
Warm Start Rx ²	45 to 60 ms (depending on radio model and temperature)
Warm Start Tx ³	55 to 70 ms (depending on radio model and temperature)
Tx Turn On Time ⁴	15 ms (typical)
RX/TX Bandwidth (without tuning)	38 MHz 136-174 (Dual), 34 MHz (406.1-440 Dual)

¹Includes 102 cm power cable

Receiver	
Sensitivity	0.35 μ V for 12 dB SINAD
Alternate Channel Selectivity (6.25 kHz)	>65 dB minimum
Adjacent Channel Selectivity (12.5 kHz)	>60 dB minimum x51 - Dual IF 6.25 & 12.5 kHz models
Adjacent Channel Selectivity (12.5 kHz)	>55 dB minimum x50 - Dual IF 12.5 & 25.0 kHz models
Adjacent Channel Selectivity (25 kHz)	>65 dB minimum
Intermodulation	>70 dB minimum
Spurious Rejection	>70 dB minimum
Conducted Spurious	< -57 dBm

¹ Cold Start: Time from DC power applied until unit is fully ready to receive or transmit data

² Warm Start Rx: In power saving modes (sleep or suspend), wake-up time for full receiver recovery

³ Warm Start Tx: In power saving modes (sleep or suspend), wake-up time for full transceiver operation

⁴ Tx Turn On Time: Typical Rx to Tx switching time for stable transmission

Transmitter	
RF Power Output	1 to 5 Watts, software adjustable
Spurious and Harmonics	<-57 dBc (-20 dBm)
Frequency Tolerance	\pm 1.5 PPM
Tx Duty Cycle	50%, max. Tx time 30 seconds, extended Tx time with the cooling fan option

Modem/Logic	
Operation	Simplex/half duplex
Data Bit Rates (b/s)	25 kHz: 4800/9600/19200; 12.5 kHz: 4800/9600
Modulation Type	DRCMSK (Differential Raise-Cosine Minimum Shift Keying)
RTS/CTS Delay (RTS mode)	4 ms
Addressing	10 bit station address, 1 bit station type (master / remote)
Bit Error Rate (BER)	12.5 kHz @ 9.6 kbps: -104 dBm, 1x10 ⁻⁶ @ 1.4 μV 25 kHz @ 4.8 or 9.6 kbps: -107 dBm, 1x10 ⁻⁶ @ 1.0 μV 25 kHz @ 19.2 kbps: -100 dBm, 1x10 ⁻⁶ @ 2.3 μV

COM Port	
Interface	EIA RS-232C
Data Rate	1200 - 19200 b/s
Protocol	Transparent, 7 or 8 data bits, 1 or 2 stop bits, even, odd or no parity
Transmit Control	RTS or DOX (data operated transmit)

Set Up Port	
Data Format	Proprietary binary for setup, ASCII for diagnostics
Data Rate	9600 b/s, 8 bit, no parity, 1 stop bit

Analog Inputs	
Interface	Two inputs, 0-10 VDC, 8 bits. May be read only via Offline Diagnostics. Absolute maximum input voltage < 20 Vdc. Inputs are reverse-voltage protected.

Digital Outputs	
Interface	Two outputs, requires external pull-up to 2 to 10 Vdc. Set via Offline Diagnostics

Display	
4 Bi-color status LEDs	RUN/PWR/ CS/SYN, RX/TX, RD/TD

Connectors	
RF	SMA Female
COM	DE-9F
SETUP/DIAG	DE-9F
Power - I/O	Snap & Lock 4-Pin DC Power Jack

Diagnostics	
Online	Short ID, temp, B+ voltage, local RSSI, remote RSSI, fwd and rev power, Rx Quality
Offline	Online plus: Demodulated Signal Voltage, Analog Input Levels, Digital Outputs

Approvals/Certifications		VHF
FCC IDENTIFIER	NP44018450	3K20F1D, 4K00F1D, 5K67F1D, 8K08F1D, 9K30F1D, 16K3F1D
IC IDENTIFIER	773B-4018450	3K20F1D, 4K00F1D, 5K67F1D, 8K08F1D, 9K30F1D, 16K3F1D

Approvals/Certifications	UHF	
FCC IDENTIFIER	NP44048350	9K30F1D, 15K3F1D
IC IDENTIFIER	773B-4048350	9K30F1D, 15K3F1D
FCC IDENTIFIER	NP44048351	3K30F1D, 3K40F1D, 8K80F1D
FCC IDENTIFIER	NP44048551	3K30F1D, 3K40F1D, 8K80F1D
IC IDENTIFIER	773B-4048351	3K30F1D, 3K40F1D, 8K80F1D
IC IDENTIFIER	773B-4048551	3K30F1D, 3K40F1D, 8K80F1D

2 GETTING STARTED

It is easy to set up an Integra-TR network to verify basic unit operation and experiment with network designs and configurations. An RX/TX antenna is required for basic operation. It is important to use attenuation between all demo units to reduce the amount of signal strength in the test environment.

2.1 DEVICE CONNECTIONS

Refer to the diagram below for the proper device connections for basic operation.

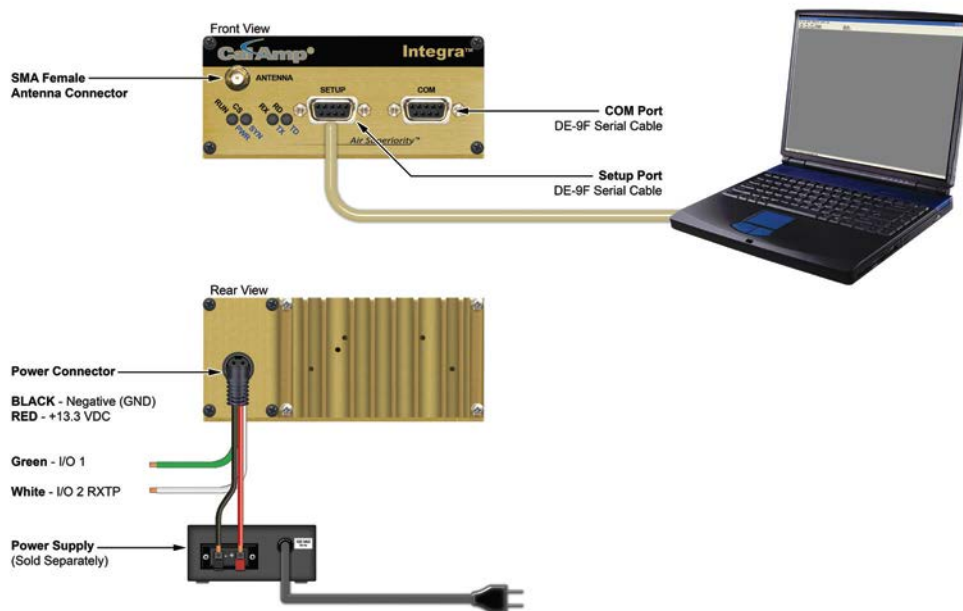

2.2 FIELD PROGRAMMING SOFTWARE

The Integra-TR Field Programming Software (FPS) is the programming and diagnostics software for the Integra-TR wireless modem. The software allows the user to edit and program user programmable settings, interactively tune modem and RF parameters, and monitor diagnostic data from the Integra-TR.

There are two specific model categories. The 2424048X50 models are the 12.5/25.0 kHz models and the 2424048X51 are the 12.5/6.25 kHz models. The models are set up at the factory. The model specific parameters are **grayed out** in the Field Programming Software and cannot be changed outside of the factory.

Integra-TR FPS is available on the Start-Up CD-ROM as a .zip file. You may also visit the Download Library available from the Support Menu at www.calamp.com for the most current version available. ***The Field Programming Software for the Integra is the professional service installer interface. The Field Programming Software should never be made available to unqualified personnel.***

2.2.1 INSTALLING THE FPS

To use the software, you will need a PC with Windows 98 or later and at least one operational COM Port available.

STEP 1 Open the .zip file and double-click on the **setup.exe** application. After the application is extracted from the .zip file, you will be brought to the Integra-TR Setup screen. Click **OK** to begin.

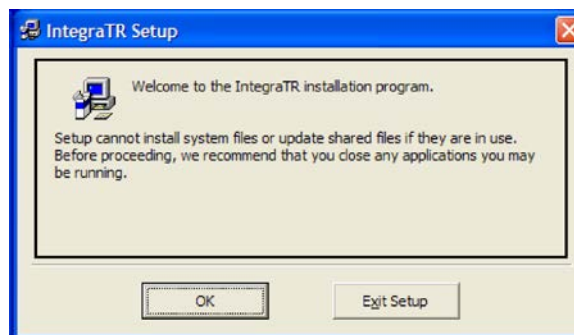

STEP 2 Click the image of the PC to install the software.

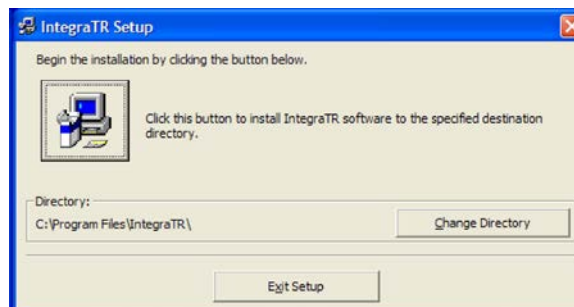

STEP 3 The program will then be added to the folder name shown in the Program Group box, the default is **Dataradio Utils**. Click **Continue** to finish the install.

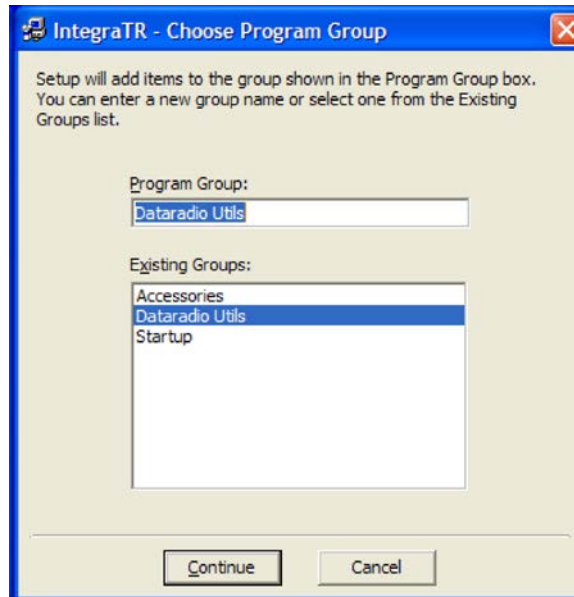

2.2.2 USING THE FPS

Make sure all connections are made as shown in the diagram and then power on the device.

STEP 1 Locate the **Dataradio Utills** folder (or if you named the Program Group box differently during install) and select the **IntegraTR** application.

STEP 2

From the Integra-TR Programmer screen, click on the **Program** button in the upper left corner. This will bring up the Program Parameters screen and display the option to automatically configure the device as a Remote or Master. Click **OK**.

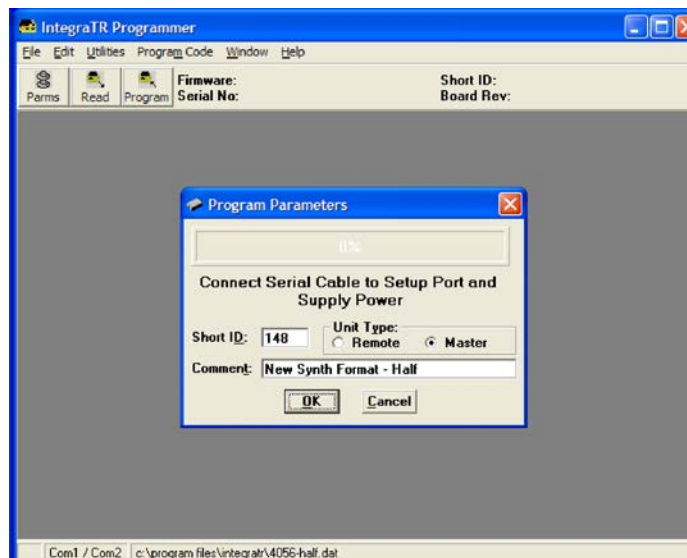

STEP 3 Click the **Parms** button in the upper left corner of the FPS screen. Here the Modem, Com/Analog, Radio and Frequencies settings can be changed. Click **OK** when done.

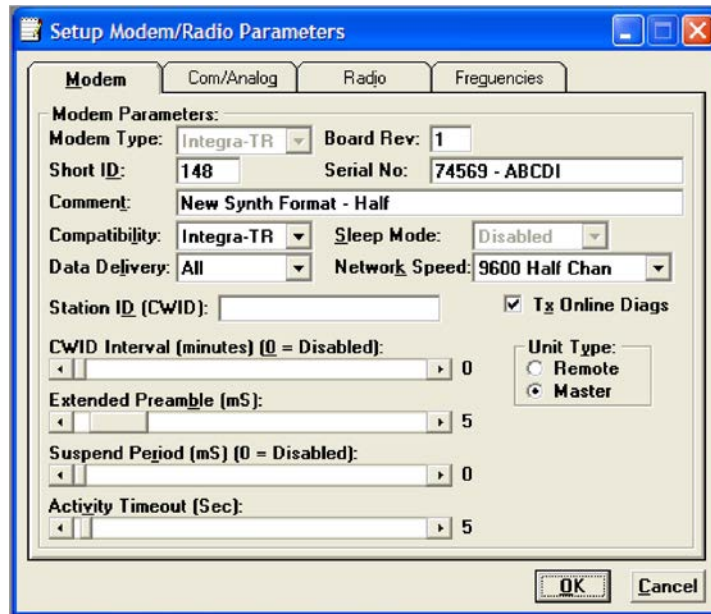

Your modem is now ready for use.

3 NETWORK APPLICATIONS

Integra-TR is suited to a variety of network applications. Its primary design goal was to satisfy the needs of SCADA systems using RTUs or PLCs in either point-to-point or point-to-multipoint service. Below is an overview of common configurations.

3.1 RF PATH AND COMMUNICATIONS RANGE

Integra-TR is designed for use over distances up to 30 miles + (50 km) depending on terrain and antenna system. To assure reliable communications, the RF (radio frequency) path between stations should be studied by a competent professional who can determine what antennas are required and whether or not a repeater is needed.

3.2 COMMON ARCHITECTURAL CHARACTERISTICS

The networks described in this section share common characteristics:

1. The DTE (data terminal equipment) network speed (1200, 2400, 4800, 9600 and 19,200 b/s) must be the same for all stations in a network.
2. Transmission of online diagnostics may be enabled or disabled at any station or stations without affecting their ability to communicate with other stations.

3.2.1 POINT-TO-POINT SYSTEM

A simple point-to-point connection is shown in Figure 7. In this system, the user's equipment (DTE) may be set up in either a peer-to-peer or a Master-Remote configuration.

Figure 7 - Point-to-Point System

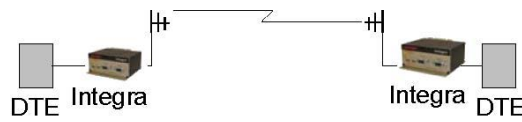

3.2.2 POINT-TO-MULTIPOINT SYSTEM

A basic point-to-multipoint system is shown in Figure XX.

Figure 8 - Point-to-Multipoint System (simplex or half-duplex)

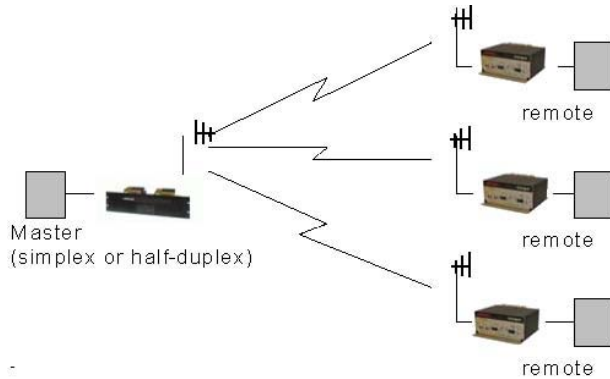

If a half-duplex radio network is used (i.e. two frequencies with the master station transmitting and receiving on the reverse pair from the remotes), the master station can be either full duplex or half-duplex.

If a simplex radio network is used (i.e. a single frequency for all stations), we recommend that the master Integra-TR be set to “master”, the remotes to “remote” and all units to “selective” data delivery. This will prevent remote stations from hearing each other's responses. For full duplex configuration, set the receiving unit Rx/Tx Mode to Rx Only (using the Field Programming Software). Set the transmitting unit mode to Tx Only.

Figure 9 - Point-to-Multipoint System (full-duplex)

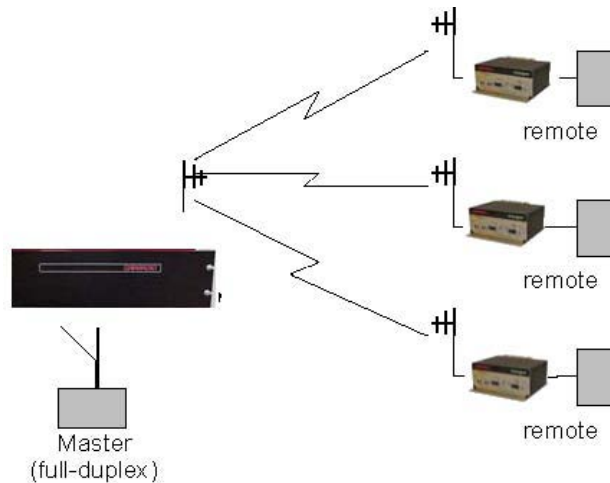
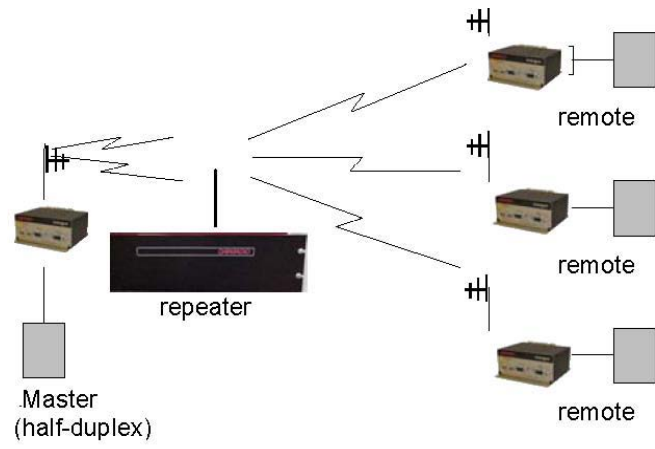

Figure 10 - Point-to-Multipoint System (full-duplex repeater)



3.2.3 EXTENDING A LANDLINE (TAIL CIRCUIT)

Integra-TR may be used to extend a landline circuit (giving access to difficult locations, etc.).

This type of connection is called a “tail circuit” and is shown in Figure 11. The tail circuit assembly may be used in any of the network types described in the preceding sections.

Figure 11 - Landline (Tail Circuit)

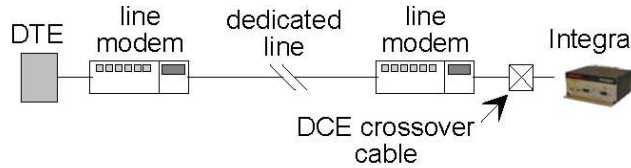

Note: The line modems should be full-duplex units.

Figure 12 - DCE Crossover Cable for RTS-CTS Mode

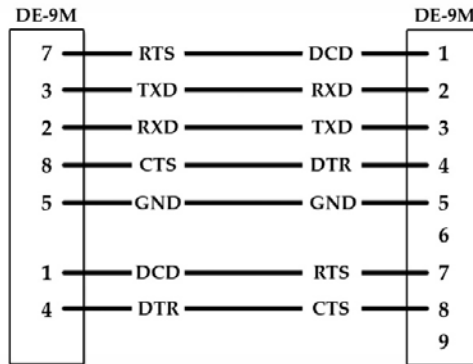

Some point-to-point FDX landline modems or line drivers may require the use of DOX mode and an alternate pinout for DTR, DCD, CTS and RTS as shown in Figure 13.

Figure 13 - DCE Crossover Cable for DOX Mode

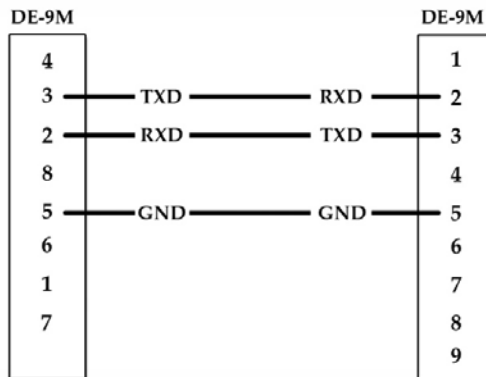

4 INTEGRA-TR FIELD PROGRAMMING SOFTWARE

The Integra-TR Field Programming Software is the programming and diagnostics software for the Integra-TR wireless modem. The Field Programming Software allows the user to edit and program user programmable settings, interactively tune modem and RF parameters, and monitor diagnostic data from the Integra-TR.

Integra Field Programming Software is available on the Start-Up Disc shipped with this device. You may also visit the Download Library available from the Support Menu at www.calamp.com for the most current FPS Version available.

To use the FPS, you will need a PC with Windows 98 or later and at least one operational COM Port available.

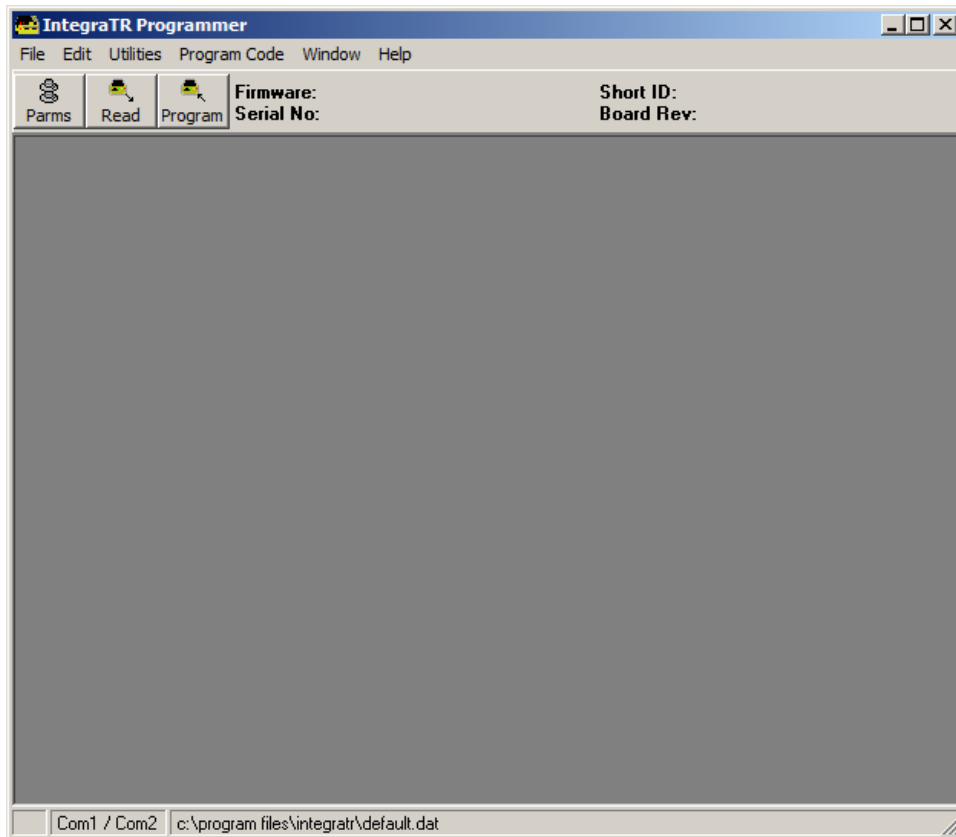

4.1 INTEGRA-TR PROGRAMMER WINDOW

Firmware updates:

The Integra-TR firmware resides in flash EPROM and is designed to allow field updates. Updates are done using a PC connected to the Integra-TR but do not require opening the unit. Updates should be coordinated by the Technical Service team.

4.2 FILE MENU

From the primary Programmer screen, the File Menu offers the following options:

- Open Data File

- Save Data File
- Save Data File As
- Open Integra Data File

Figure 14: Integra-TR Programmer – File Menu

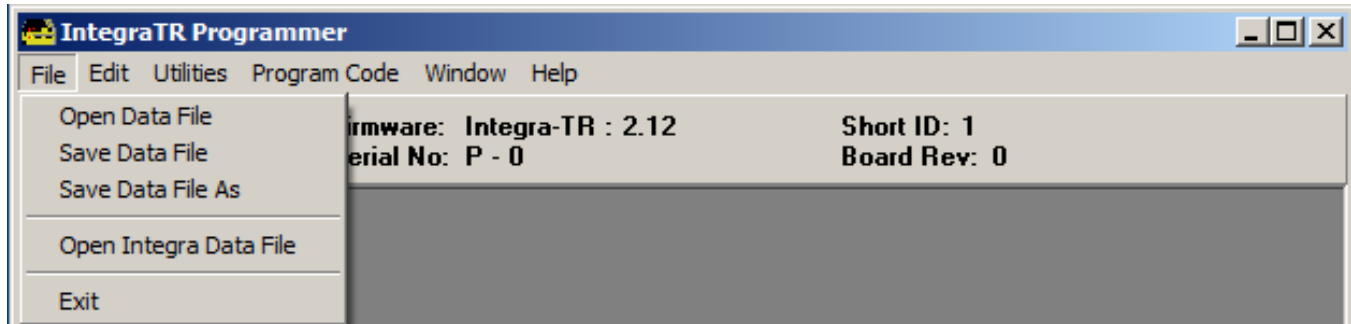

4.3 EDIT MENU

From the primary Programmer screen, the Edit Menu offers the following options:

- Setup Modem/Radio Parameters
- Version Request
- List Information
- Apply Integra Reset
- Program/Comment ID
- Program Parameters
- Read Parameters
- Copy Parameters

Figure 15: Integra-TR Programmer – Edit Menu

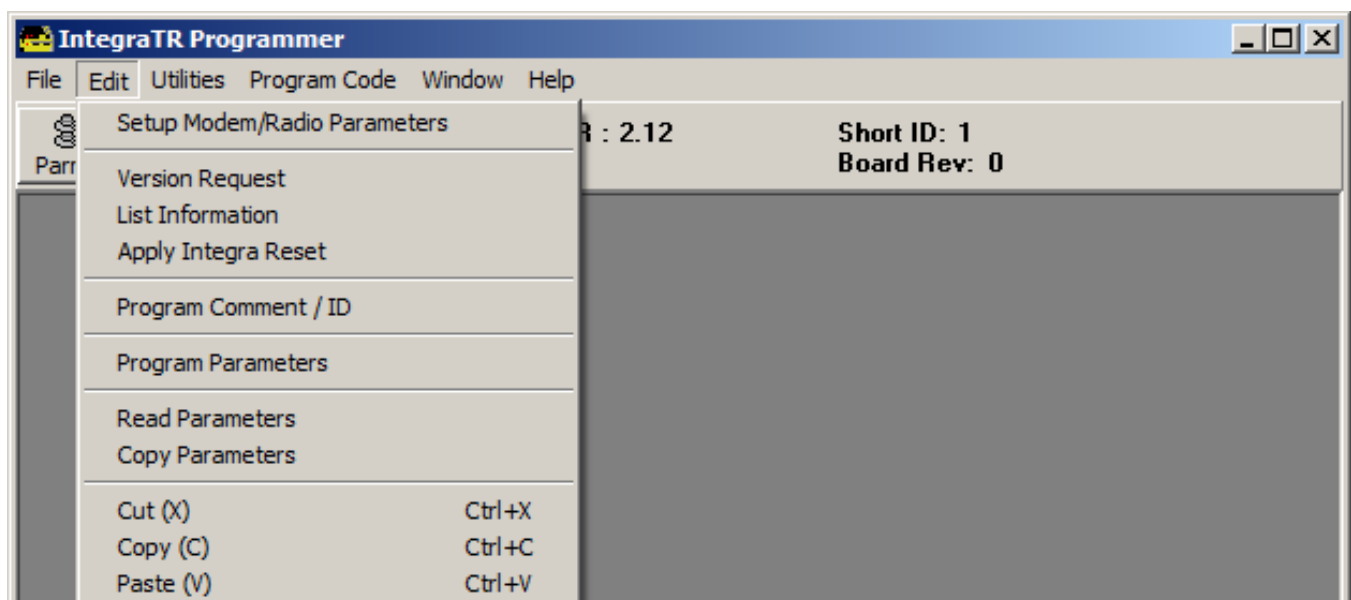

4.3.1 SETUP MODEM/RADIO PARAMETERS

To access the Setup Modem/Radio Parameters screen, use the Parms Icon. You may also access this screen from the Edit menu.

Setup Modem/Radio Parameters allows the user to view and edit Integra-TR's programmable parameters. Programming parameters can be stored in a data file with the .DAT file extension. Programmable parameters are used by the Read/Program Parameters screen for programming into nonvolatile memory (see This section describes the Modem Operating Parameters shown in Figure 15.

Figure 16).

Parameter settings are modified from four screen tabs: the Modem tab, Com/Analog tab, Radio tab and Frequencies tab.

Once the desired parameters have been entered for each window, select **OK** to store the parameter information into local PC memory or select **Cancel** to exit the Set up screen without making any modifications to the currently stored parameter file.

4.3.1.1 SET UP MODEM/RADIO PARAMETERS: **MODEM TAB**

This section describes the Modem Operating Parameters shown in Figure 15.

Figure 16: Setup Modem/Radio Parameters – Modem Tab

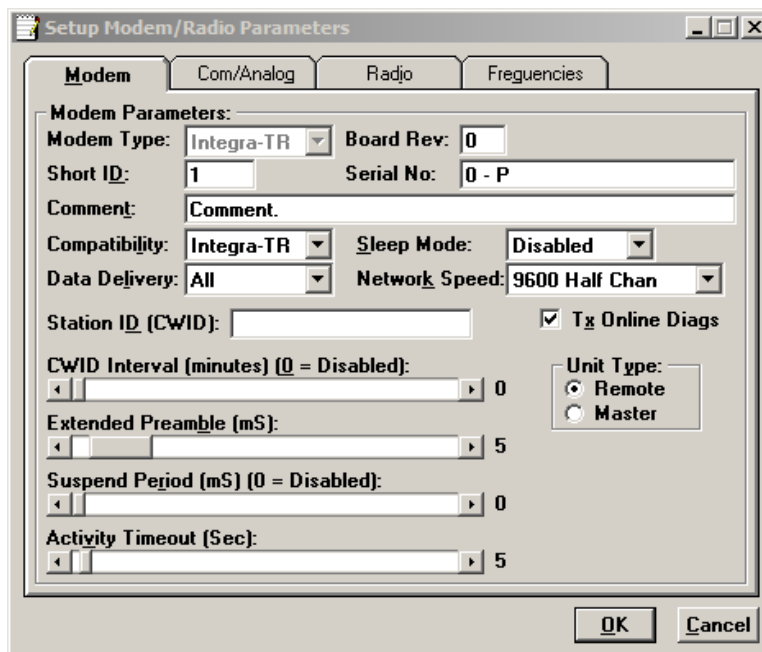

- **Modem Type**
Displays the Modem type of the connected device
- **Board Rev**
Displays the hardware revision number of the modem board in the connected device

- **Short ID**
Enter a Short ID number that will be used to identify an individual device within the network. Short IDs may range from 1 to 254 or from 256 to 1023. Short ID 255 is reserved. Note: Firmware versions 2.10 and earlier only allow short IDs of 1-254.
- **Serial No.**
Displays the serial number for the modem board of the connected device.
- **Comment**
Integra-TR Field Programming Software supplies this field for user-convenient description(s): customer name, location. technical info...). Comments can be text up to 24 characters in length, including spaces.
- **Compatibility**
Select Integra-TR or Integra-T to configure the compatibility mode for use with previous Integra models.
 - Integra-TR - used for networks made up of Integra-TR wireless modems.
 - Integra-T/TR - used for “on-air” backward compatibility with the Integra-T for bit rates of 4800 and 9600 b/s (full channel units only). The Integra-TR is capable of selectable network speeds of 4800 and 9600 b/s for half-channel units (12.5 kHz) or 4800, 9600, 19200 b/s for full-channel units (25 kHz). Use the Integra-TR mode whenever feasible.
- **Sleep Mode**
Select Enabled/Disabled. When enabled, the unit is in low power consumption (approximately 15 mA). In Sleep Mode, the Integra-TR cannot detect the presence of a carrier. Only asserting RTS on the COM or Setup ports will wake the unit. It is ready to receive and decode data within 45 to 65 mS (dependent on Integra model and temperature) after wake-up.
- **Data Delivery**
Select All/Selective. This field determines if data should be delivered to the COM port. Designating a unit as Master or Remote sets a flag in the header identifying the Unit Type of the originating station:
 - All - this option causes the unit to accept (on the receive side) all data transmissions.
 - Selective - this option causes the unit to accept (on the receive side) data only if it originates from a unit of the opposite Unit Type (i.e., a Master will only accept data from a Remote and a Remote will only accept data from a Master).
- **Network Speed**
Select the bit rate of the RF link between units. This can be different from the COM Port baud rate. **This setting must be the same for all units in the network.**
 - 4800 b/s - selectable for, half- and full-channel models and for full-channel models.
 - 9600 b/s - selectable for half- and full-channel models and for full-channel models.
 - 19200 b/s - selectable for full-channel models only.
- **Tx Online Diags**
Check box to enable Online Diagnostics; Refer to Section XX for more information on Diagnostics and their effect on the radio network
- **Unit Type**
Radio button selection for Master or Remote configuration

- Station ID (CWID)**
 Enter the Station ID (CWID) or FCC Call Sign for the system. It is sent out as Morse Code at predetermined intervals. Station ID is a combination of letters (upper-case) and numbers (0 - 9) up to 9 characters in length.
- CWID Interval**
 CWID Interval is used to set the interval of time the unit will transmit the Station ID (CWID) or FCC Call Sign. The range is 1 to 255 minutes in 1 minute intervals, with 0 being disabled. To enable the transmissions of the Station ID (CWID) or FCC Call Sign, a non-zero value must be set for the CWID Interval. Only one unit in a system should be programmed to transmit the Station ID (CWID), typically the Master.
- Extended Preamble**
 This field extends transmitted synchronization time when the unit is used in a network with repeaters. The default is 5 mS and the range is 0 to 100 mS in 5 mS intervals. Add 10 mS for each Repeater an Integra-TR communicates through in a network (dependent on user's protocol). **Note: Units supplied or updated prior to November of 2001 use a default value of 0 mS for Extended Preamble. Extensive testing has shown 5 mS to be the most robust setting. If timing is critical in your application, this value can be set back to 0 mS.**
- Suspend Period**
 Set the length of time the Integra-TR goes to cycled lower power mode. The range for Suspend Period is from 50 to 12,000 mS in 50 mS intervals. Setting this range to a value of 0 disables Suspend Period.
- Activity Timeout**
 Activity Timeout is used to set the minimum length of time the unit will remain awake in the presence of a carrier - range is 1 to 255 seconds in 1 second intervals. This field is active only if Suspend Period is enabled. A non-zero value must be set to enable Suspend Period. The same Activity Timeout and Suspend Period values must be set for both Master and Remote units. See Figure 17 for a Suspend Mode Timing graphic.

Figure 17: Suspend Mode Timing

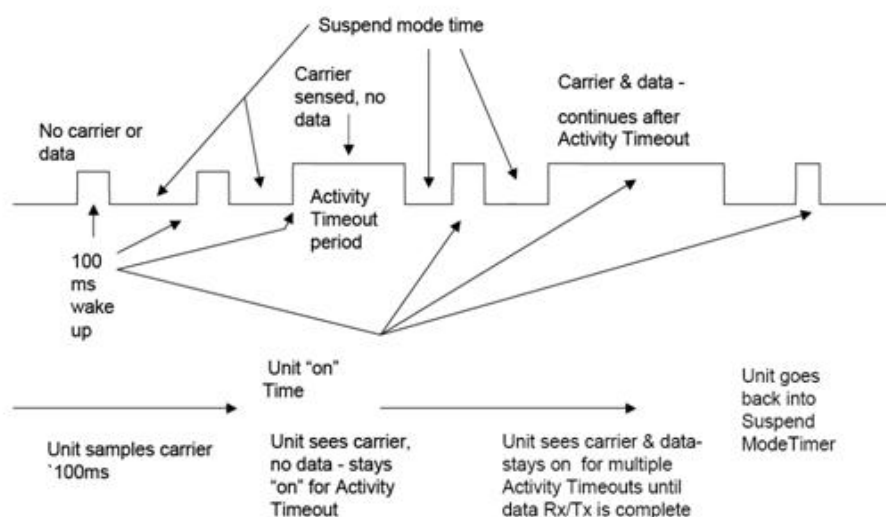

4.3.1.2 SET UP MODEM/RADIO PARAMETERS: COM/ANALOG TAB

The COM/Analog tab allows user programming of various COM Port and External input/output parameters (see Figure 18).

Figure 18: COM/Analog Setup Parameters Screen

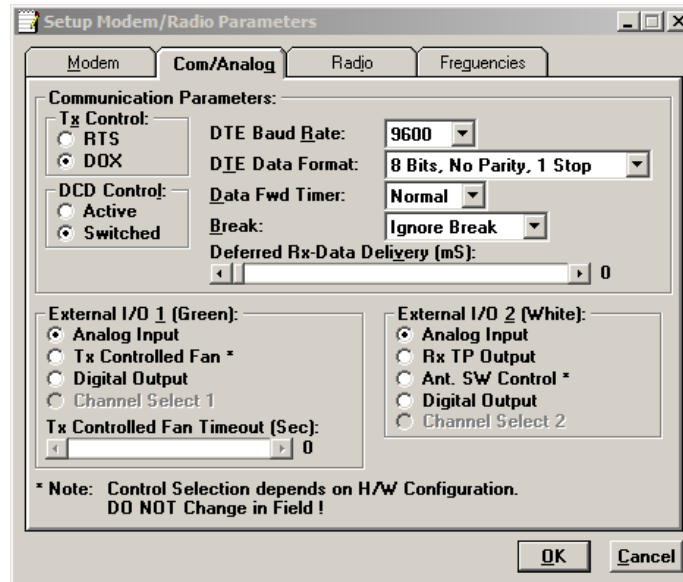

4.3.1.2.1 COMMUNICATION PARAMETERS

- **Tx Control**

This radio button selects the unit's mode at the beginning of a transmission

- RTS – Request to Send
- DOX – Data Operated Transmit

The Transmit Control default mode is DOX in which the unit begins a transmission as soon as data is presented to the COM Port. The optional mode is RTS in which the unit begins transmission only when the RS-232 RTS input pin of the COM Port is raised and continues transmitting until the RTS is dropped. Selecting RTS also activates the switched option in DCD control.

Figure 19: Integra-TR Control Signal Timing

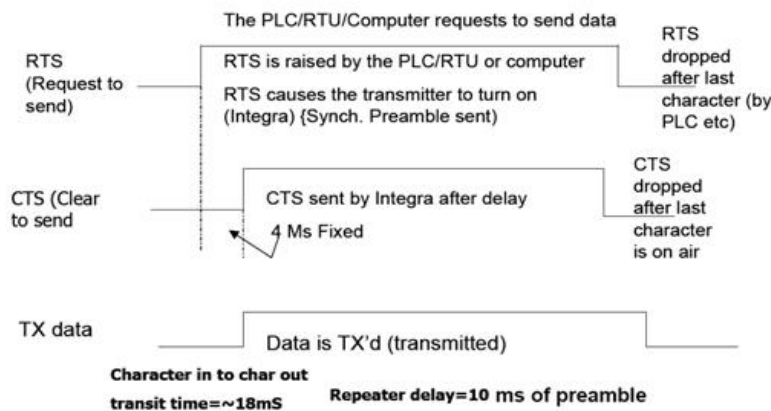

- **DCD Control**

Radio button selection for RS-232 DCD (Data Carrier Detect) mode

- Active – DCD is always asserted
- Switched – follows the radio carrier and data sent to DTE

- **DTE Baud Rate**

Select **1200/2400/4800/9600/19200** to configure the port speed of the COM Port

- **DTE Data Format**

User Selectable; Default = 8 bits, no parity, 1 stop. Other options include:

- 8 bits, no parity, 2 stop
- 8 bits, odd parity, 1 stop
- 8 bits, odd parity, 2 stop
- 8 bits, even parity, 1 stop
- 8 bits, even parity, 2 stop
- 7 bits, no parity, 1 stop
- 7 bits, no parity, 2 stop
- 7 bits, odd parity, 1 stop
- 7 bits, odd parity, 2 stop
- 7 bits, even parity, 1 stop
- 7 bits, even parity, 2 stop

- **Data Fwd Timer**

User Selectable to set the timing between data blocks in a transmission to accommodate some RTU's special timing requirements:

- Normal = 15 ms (default)
- Fast = 5 ms (do not use for baud rates below 2400 b/s)

- **Break**

Select the device response to break signals (protocol dependent) on the COM Port:

- Ignore break - unit does not transmit or receive break signals
- Transmit break - unit transmits and receives break signals

- **Deferred Rx-Data Delivery**

This field sets the period of time the unit waits until delivering received data to the COM Port. Range is 0 to 255 ms in 1 ms intervals (keeps delays minimum for protocols susceptible to inter-character delays).

4.3.1.2.2 EXTERNAL I/O PARAMETERS

4.3.1.2.2.1 EXTERNAL I/O 1 (GREEN)

These radio buttons select configuration of Pin 3 on the Power - I/O Connector (green wire):

- **Analog Input**
An option on units not equipped with the cooling fan option - can be used to monitor an external voltage (0 to 10 volts). Monitoring is from the Offline Diagnostics screen
- **Tx Controlled Fan**
Selecting this option will cause the unit to turn the fan ON at the start of a transmission and OFF after a predetermined timeout (TX Controlled Fan Timeout) at the completion of a transmission. The length of time the fan is on is the length of the transmission plus the timeout time. This option is displayed for versions of firmware that support fan control output based on transmissions (Ver 2.04 and later).
- **Digital Output**
An option for units not equipped with the cooling fan option. This connection can be used to control the open-collector transistor on the connector. The open-collector output can sink a maximum current of 100 mA when the modem board rev is 0 or 1. The output is controlled from the Offline Diagnostics screen. **Error! Reference source not found.** shows the Field Programming Software interface for Digital I/O.
- **Channel Select 1**
For use with models NOT equipped with the cooling option. This setting will configure the connection to be an analog input for 2 or 4 Channel Select Mode. If Channel Select 2 is NOT selected, this input and Channel Select 2 input selects between Channels 1, 2, 3 and 4. A low level (logic 0) is a voltage less than the Channel Select Voltage and a high level (logic 1) is a voltage greater than the Channel Select Voltage. The Channel Select Voltage is selected on the Radio Tab. For 2 Channel Select Mode, see Table 6 "4 Channel Select Mode". If configured as a Digital Output, the open-collector transistor requires an external pull-up (i.e., resistor) to a voltage of 2 to 10 volts.
- **Tx Controlled Fan Timeout**
Used to set the interval of time the unit will keep the fan turned ON after a transmission is completed. The range is 5 to 255 seconds in 1 second intervals.

4.3.1.2.2.2 EXTERNAL I/O 2 (WHITE)

These radio buttons select configuration of Pin 4 of the Power - I/O Connector (white wire):

- **Analog Input**
For use on units not equipped with the cooling option - can be used to monitor an external voltage (0 to 10 volts)
- **Rx TP Output**
Performs as the demodulated signal level test point. The Rx TP level is half of the internal Rx Test Point
- **Ant. SW Control**
Supports the use of a redundant base station. Ant. SW Control configuration is dependent on hardware configuration and should not be changed in the field

- **Digital Output**

This connection can be used to control the open-collector transistor on the connector. The open-collector output can sink a maximum current of 40 mA when the modem board rev is 0 and 100 mA when the modem board rev is 1. The output is controlled from the Offline Diagnostics screen NOTE: When configured as a Digital Output, the open-collector transistor requires an external pull-up (i.e., resistor) to a voltage of 2 to 10 volts. Note: When configured as a Digital Output, the open collector transistor requires an external pull-up (i.e., resistor) to a voltage of 2 to 10 volts.

- **Channel Select 2**

Select to configure the connection to be an analog input for 2 or 4 Channel Select Mode. If Channel Select 1 IS NOT selected, this input selects between Channels 1 and 2. If Channel Select 1 IS selected, this input and Channel Select 2 input selects between Channels 1,2,3 and 4. A low level input and Channel Select 2 input selects between channels 1,2,3 and 4. A low level (logic 0) is a voltage less than the Channel Select Voltage and a high level (logic 1) is a voltage greater than the Channel Select Voltage. Channel Select Voltage is selected on the Radio Tab. For 2 Channel Select Mode, a low level input will select channel 1 and a high level will select Channel 2. For 4 Channel Select Mode, see Table 6.

Table 6 - 4 Channel Select Mode

	Channel Select 2	Channel Select 1
Channel 1	low	low
Channel 2	low	high
Channel 3	high	low
Channel 4	high	high

4.3.1.3 SET UP MODEM/RADIO PARAMETERS: **RADIO** TAB

The Radio tab allows user programming of various radio parameters.

Figure 20: Radio Setup Parameters Screen

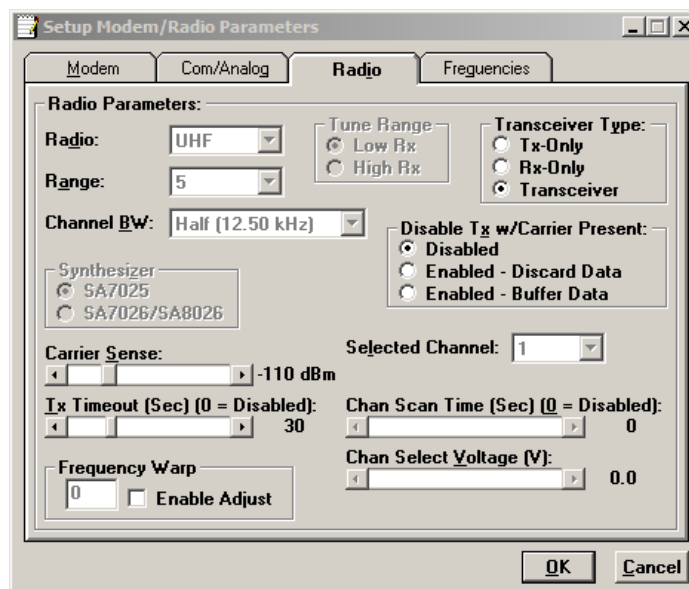

- **Radio**
Display the model of the connected radio device
- **Range**
Displays the range number of the connected radio device
- **Channel Bandwidth**
Displays the channel bandwidth of the connected device: Half-channel (12.5 kHz) or Full-channel (25 kHz)
- **Transceiver Type**
Radio button selection for user configuration of transmit and receive characteristics of the device in accordance with the type of network application:
 - Tx Only – For use in a full-duplex application to disable receptions on the unit used as the transmitter. Tx Only designation pre-loads the synthesizer and allows faster attack time to speed up transmission response.
 - Rx Only – For use in a full-duplex application to disable transmissions on the unit used as the receiver. Rx Only designation prevents accidental transmissions.
 - Transceiver – For use in all other applications.
- **Disable Tx w/Carrier Present**
Provides the following options to configure unit reaction to an RF carrier presence when a transmission is to begin:
 - Disabled - Select this option to instruct the unit to allow a transmission when a carrier is present.
 - Enabled (Discard data) - Select this option to instruct the unit not to allow a transmission if a carrier is present. Any user data the unit receives on the COM Port while a carrier is present, is ignored and discarded.
 - Enabled (Buffer data) - Select this option to instruct the unit not to allow a transmission if a carrier is present. Any user data the unit receives on the COM Port while a carrier is present is buffered and sent when the carrier is no longer present.
- **Carrier Sense**
Denotes the RSSI level when the unit senses a carrier. Carrier Sense is used for data recovery, in the interpretation of diagnostics, and to turn on the front panel CS LED. The threshold may be raised to prevent false Carrier Sense operation in the presence of noise, inter-modulation, or other sources of interference (i.e. for ambient noise at -100 dBm, set the Carrier Sense for -95 dBm).
- **Tx Timeout**
Used to set maximum period of time the unit will allow in a transmission. The range is 0 to 120 seconds in 1 second intervals (0 being disabled). Tx Timeout is used to protect both the unit and the network in case a transmitter becomes stuck on the air. For Integra-TRs equipped with the cooling option for extended transmit applications, the Tx Timeout must be disabled. Warning: Disabling the timer may disrupt the network or damage the unit should it become stuck in transmit due to excessive user data received on the COM port or the if the RTS signal remains active.

- Selected Channel**
 This field allows the user to choose a selected channel pair for receiving and transmitting. Allowable entries are 1 to 16. The selected channel will be used if Channel Select 1 and Channel Select 2 are NOT selected. (COM/Analog Tab). Note: This feature is disabled when a Channel Select Line is enabled (green or white wire).
- Chan Scan Time**
 Allows the user to configure the modem to switch (increment from the Selected Channel) to a new channel if it has not received a valid data packet for this programmable time. This is programmable in steps of 20 seconds (60 to 5000 seconds, or 1 to 83 minutes). Setting Chan Scan Time to zero disables channel scan operation and the modem remains on the selected channel. Note: This feature is disabled when Sleep/Suspend Period is enabled, when Master Mode is enabled or when a Channel Select Line is enabled (green or white wire).
- Chan Select Voltage**
 Allows the user to determine voltage thresholds for Channel Select 1 (green) and Channel Select 2 (white) inputs (if programmed). A low level (logic 0) is a voltage less than the set voltage threshold and a high level (logic 1) is a voltage greater than the set voltage threshold. Note: Multi-Channel operation is available in modem firmware version 2.20 and later.

4.3.1.4 SET UP MODEM/RADIO PARAMETERS: FREQUENCIES TAB

The Frequencies Tab allows the user to program the radio channels (Frequency Pairs).

Figure 21: Frequencies Tab

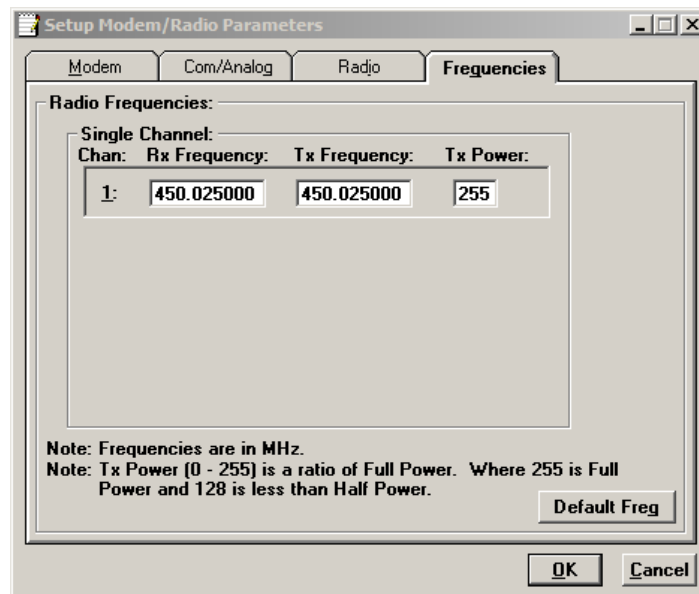

- Rx Frequency**
 Enter the Rx frequency of the designated receive channel
- Tx Frequency**
 Enter the Tx frequency of the designated transmit channel. There are 12 VHF splinter channels available for quarter-channel VHF (6.25 kHz) Integras.

The frequencies for these splinter channels are:

154.456250
154.463750
154.471250
154.478750
173.203750
173.237500
173.262500
173.287500
173.312500
173.337500
173.362500
173.396250

▪ **Tx Power**

This field designates the channel pair Power Output Adjust value. The default value is 255 (5 watts). This value should be left at the default value unless lower power is required to meet regulatory requirements, to increase the allowable transmit duty cycle or to reduce transmit power. As the output is adjusted downward (less RF output power) the overall current requirements of the Integra are lessened. When optimizing a system for operational parameters such as RF coverage and over all power (current) usage, the correct amount of RF power needed for coverage may actually be less than full (5 watts) output. This in turn can lower overall power (current) needs of the wireless modem. **NOTE: Power does not vary linearly with this parameter so some experimentation may be required to determine the correct power setting.**

4.3.2 VERSION REQUEST

From the Programmer Window, Select **Edit – Version Reset** to display the following information about the connected device.

- Integra-TR: displays the Modem Firmware Version Number)
- Serial Number: displays the serial number of the modem module
- Short ID: displays the Short ID of the connected device. Refer to Section XX to program the Short ID.
- Comment: displays the comment field for the connected device. Refer to Section XX to enter a user comment.
- Board Rev: Displays the board revision number of the connected device.

Figure 22: Version Request Screen

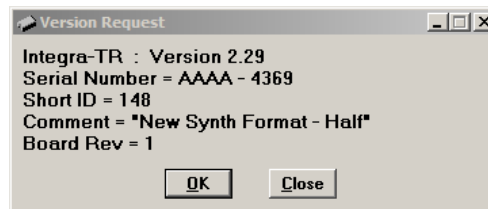

4.3.3 LIST INFORMATION

From the Programmer Window, Select **Edit – List information** to display the following information about the connected device. The List Information Utility is a diagnostic tool for the modem’s firmware. This information will be required when consulting with the Technical Support Department.

Figure 23: List Request Screen

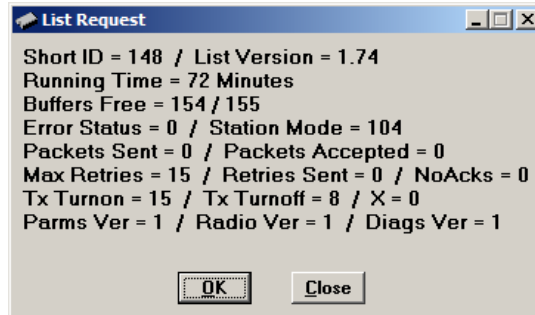

4.3.4 APPLY INTEGRA RESET

From the Programmer Window, Select **Edit – Apply Integra Reset** to access the Reset Utility. Integra Reset tells the Integra-TR to perform a software reset. Select OK to perform station reset. The reset action performs the same function as cycling power to the device.

Figure 24: Apply Integra Reset Screens

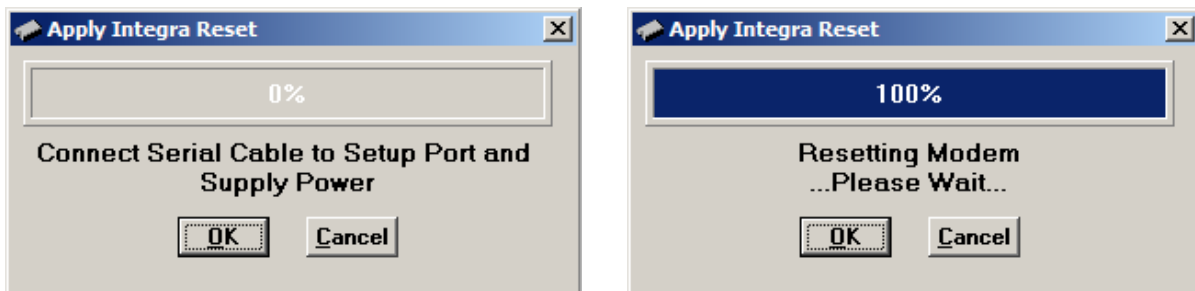

4.3.5 PROGRAM COMMENT/ID

From the Programmer Window, Select **Edit – Program/Comment ID** to access the Program Comment/ID configuration screens. This utility is particularly useful if the Integra-TR being programmed was cloned from another unit (See Figure 25).

Figure 25: Program Comment/ID Screen

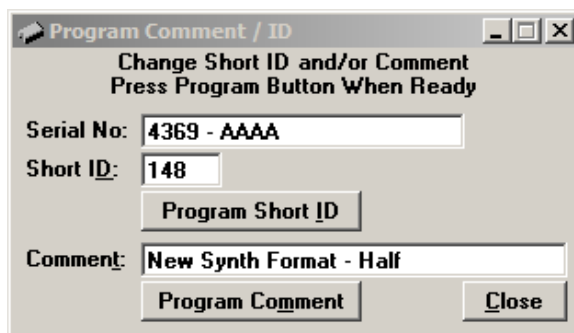

- **Short ID**
Enter a number (from 1 to 254 and 256 to 1023 - 255 is reserved) used to identify an individual unit within the network. You must click the **Program Short ID** button for changes to take effect.
- **Comment**
Enter a short description that may be used to identify the device. Comments often include a name, a location, technical information, or other user desired information. Comment fields must be in text format and are limited to 24 characters, including spaces. You must click the **Program Comment** button for changes to take effect.

4.3.6 PROGRAM PARAMETERS

From the Programmer Window, Select **Edit – Program Parameters**. Program Parameters allows the user to program the currently loaded programmable parameters to the Integra-TR (the ID Number, Comment and Remote/Master settings are extracted from the fields on the screen). This option can be used for programming the same Data File (.DAT) into multiple modems (if .dat file is imported into the parameters field, the Short ID, Comment and Remote/Master settings will be changed - verify correct ID, Comment and Remote/Master BEFORE clicking OK). At the completion of programming, the ID Number will automatically be incremented.

Figure 26: Program Parameters

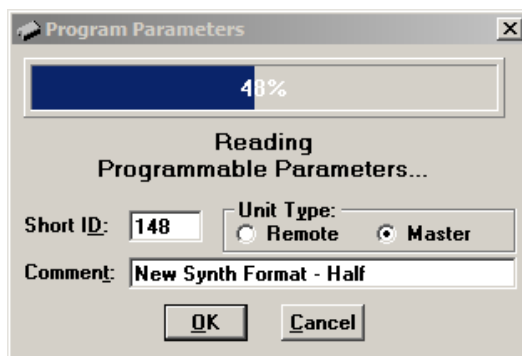

4.3.7 READ PARAMETERS

From the Programmer Window, Select **Edit – Read Parameters**. The Read Parameters function tells the Integra-TR to pull the parameters that are currently programmed in the Integra-TR. To view these parameters, click the **Parms Icon** after running the Read utility.

4.3.8 COPY PARAMETERS

From the Programmer Window, Select **Edit – Copy Parameters**. This allows the user to write the currently loaded programmable parameters to the Integra-TR (including the ID Number, Comment and Remote/Master Settings).

4.4 UTILITIES MENU

From the primary Programmer screen, the Utilities Menu offers the following options:

- Port Settings
- Swap Com Ports
- Port Statistics
- Offline Link Test
- Offline Diagnostics
- Online Diagnostics
- Diagnostic IDs and Alarms
- User Test
- Packet Test
- Array Test
- Ping Test
- ASCII Terminal
- Hex Terminal

Figure 27: Integra-TR Programmer – Utilities Menu

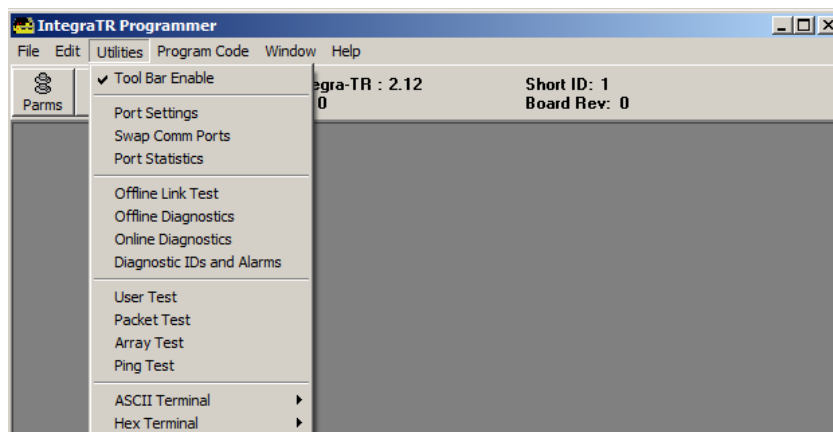

4.4.1 PORT SETTINGS

From the Programmer Window, Select **Utilities – Port Settings**

Integra-TR programming is done through the PC's Primary COM Port. Primary and secondary COM ports are configured with the Field Programming Software. The programming cable (included in the Programming Kit - DRL part number 250-4008-001) is connected from the Setup Port on the Integra-TR to the PC's COM port configured as the Primary Port. The Port Settings screen of the Field Programming Software is accessed via the Utilities pull-down menu.

The Port Settings screens are used to configure the PC's serial COM Ports. COM Port parameters are defined in 2.4.2.1. COM Port assignments are displayed in the bottom status bar of the Integra-TR Field Programming Software screen.

Figure 28 – COM Port Settings Screen

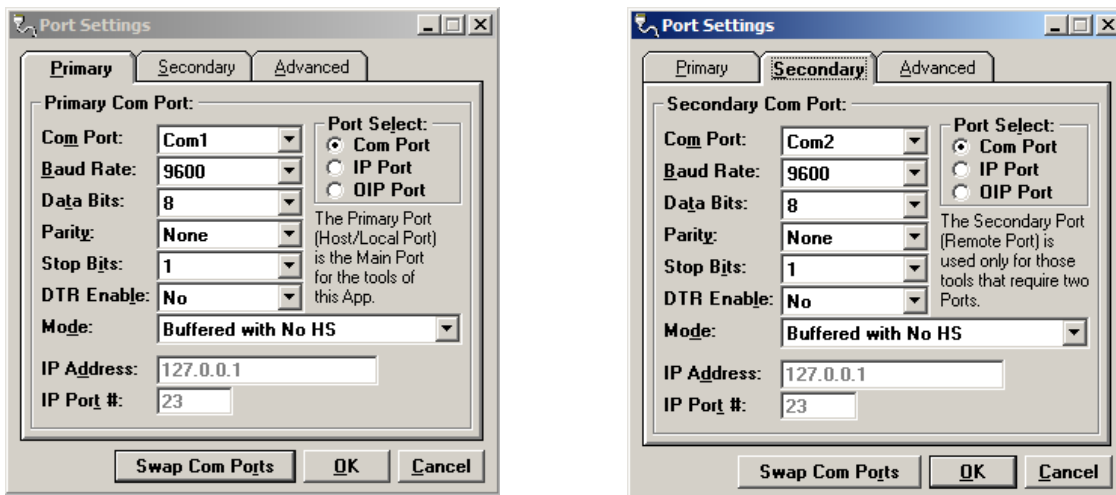

4.4.1.1 PRIMARY/SECONDARY COM PORT PARAMETERS

- **COM Port**
Select COM 1-32 to identify the Port number to be used for the Primary and Secondary COM ports
- **Baud Rate**
Select 1200, 2400, 4800, 9600, 19200, 38400 or 115200 to set the communication speed for Primary and Secondary COM Ports
- **Data Bits**
Select 7 or 8 for the number of data bits transmitted or received for the Primary and Secondary COM Ports
- **Parity**
Select Even, Odd, or None for the transmission or reception of any Parity Bits for the Primary and Secondary COM Ports

- **Stop Bits**
Select 1 or 2 for the number of Stop Bits transmitted or received for the Primary and Secondary COM Ports
- **DTR Enable**
Select Yes/No. Enable to assert the DTR (Data Terminal Ready) line of the RS-232 Port when the port is open for the Primary and Secondary COM Ports.
- **Mode**
Select the communication mode to be used by the Integra-TR. Refer to Table XX for Communication Mode descriptions.

Table 7 – Communication Mode Descriptions

Mode	Description
Sync/ESC with No HS	Sends data using Sync/byte-stuffing protocol without handshaking.
Buffered with No HS	Sends buffered data without handshaking (this mode is required for DOX operation.)
Sync/Esc with RTS/CTS HS	Sends data using the Sync/Esc byte-stuffing protocol with RTS/CTS hardware handshaking.
Buffered with RTS/CTS HS	Sends buffered data with RTS/CTS hardware handshaking.
Sync/Esc with Flow Control HS	Sends data using the Sync/Esc byte-stuffing protocol with flow control handshaking.
Buffered with Flow Control HS	Sends buffered data with flow control hardware handshaking.

- **IP Address/Port Number**
Selection of an IP Address and Port Number when IP Port is selected.. The Ethernet-to-RS-232 converter with this IP Address must have a TCP (Telnet) server enabled. Allows the user to select the IP Port number used if the Port Select has IP Port selected. This is the Port Number that will be used to make a TCP (Telnet) connection.
- **Port Select**
Allows the user to choose data transmissions and receptions on a specified RS-232 COM port or an Ethernet adapter via TCP (Telnet)
 - **Com Port** – System data will be transmitted and received using the specified RS-232 COM port.
 - **IP Port** – System data will be transmitted and received over the Ethernet to a specified IP address and port number using the TCP (Telnet) protocol. Select this option if an Ethernet to RS232 converter is implemented for the unit under test.
 - **OIP Port** – This option should not be selected for Integra-TR models.

Figure 29 – Port Settings Advanced Tab

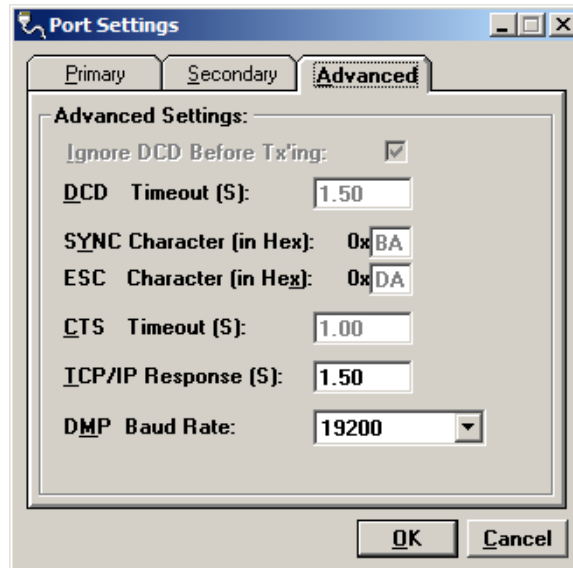

- **Ignore DCD Before Tx'ing**
Allows the user to check for an inactive DCD before transmitting. If selected, no data is sent until DCD becomes active
- **DCD Timeout**
If Ignore DCD Before Tx'ing is selected, DCD Timeout determines the length of time to wait for DCD to become inactive before data is sent. If the DCD does not become inactive during this time, the data is not sent.
- **SYNC Character**
Allows the user to select the SYNC character when utilizing a Sync/Esc (Framing) Mode. The Sync Character is the first character of a frame to be sent. This character is a HEX character.
- **ESC Character**
Allows the user to select the ESC character when utilizing a Sync/Esc (Framing) Mode. The ESC Character precedes any embedded SYNC or ESC characters that follow the initial SYNC character. This character is a HEX character.
- **CTS Timeout**
Selects the RTS to CTS timeout when using an RTS/CTS hardware handshaking mode. This is the amount of time (in 50mS increments) the software will allow for the CTS line to become active after asserting the RTS line.
- **TCP/IP Response**
Enter a time interval between 1.5 and 600 (seconds) to allow for the Unit to respond to Programming Commands over a TCP/IP Connection. The value of this may require the use of the About Utility. By pinging the destination IP Address, the utility will give back Minimum / Maximum / Average Times it takes to send and receive a packet over the TCP/IP Connection. A safe value will be to use the Maximum Time (in seconds).

- **DMP Baud Rate**
Select 1200, 2400, 4800, 9600, 19200, 38400 or 115200 to set the communication speed for Primary and Secondary COM Ports when using the DMP Protocol. DMP is used to talk to the Integra modems through the Setup Port.
- **SYNC/ESC Framing**
A typical SYNC/ESC frame will look like the following character stream.

SYNC	ML	Data0	-----	DataN	Chksum
8 bits	8 bits	8 bits	-----	8 bits	8 bits

And the following definitions are made:

- **SYNC (8 bits)**
Marks the start of a frame when not preceded by an ESC character. When using a Sync/Esc (Framing) Mode, the software will stuff this character automatically.
- **ML (8 bits)**
The length of frame is given by ML. ML is the number of characters left to be received including the checksum but excluding any ESC characters added as part of the protocol. When using a SYNC/ESC (Framing) Mode, the software will stuff this character automatically (based on the number of data characters).
- **Data 0 - N (8 bits each)**
Frame information.
- **Chksum (8 bits)**
This is the 8 bit 2s complement of the sum of the frame less the SYNC character and any additional ESC characters added (ignoring the carry out of the high order bits. When using a SYNC/ESC (Framing) Mode, the software will stuff this character automatically.

4.4.2 SWAP COM PORTS

From the Programmer Window, Select **Utilities – Swap Com Ports**

This allows the user to swap the settings for the primary and secondary COM Ports. Since programming is done through the Primary port, this is useful when programming multiple units. If a unit is connected to the Primary port, and another unit is connected to the Secondary port, Swap COM Ports allows the second unit to be programmed without switching programming cables. Swap COM Ports is also available from the Port Settings Primary and Secondary Port screens.

4.4.3 PORT STATISTICS

From the Programmer Window, Select **Utilities – Port Statistics**. This shows the current parameters of the PC's primary and secondary COM ports.

Figure 30: Port Statistics Screen

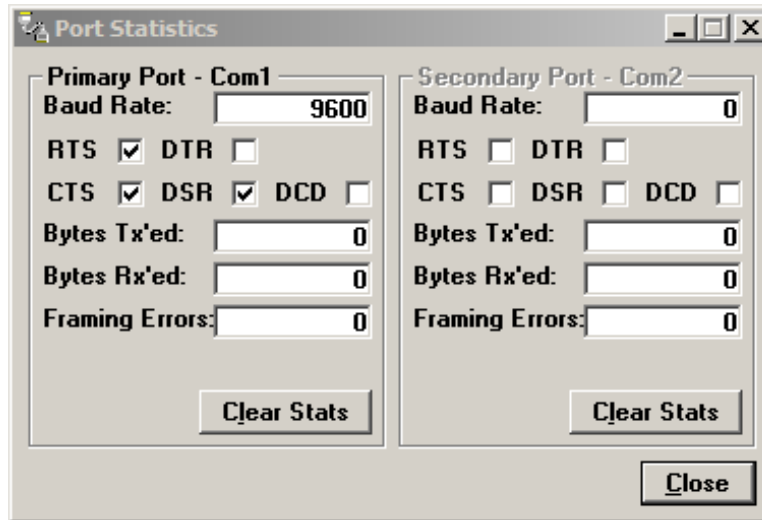

- **Baud Rate**
Displays the current setting for the utilized COM port
- **RTS**
RTS is an output from the user connected DTE device. This will be checked if active.
- **DTR**
DTR is an output from the user connected DTE device. This will be checked if active.
- **CTS**
CTS is an input to the user connected DTE device. This will be checked if active.
- **DSR**
DSR is an input to the user connected DTE device. This will be checked if active.
- **DCD**
DCD is an input to the user connected DTE device. This will be checked if active.
- **Bytes Tx'ed**
Displays the number of bytes (characters) transmitted since the port was last opened.
- **Bytes Rx'ed**
Shows the number of bytes (characters) received since the port was last opened.
- **Framing Errors**
Shows the number of Framing Errors received since the port was last opened.

4.4.4 OFFLINE LINK TEST

From the Programmer Window, Select **Utilities – Offline Link Test**

The Offline Link Test is used to test the link between two units – the local unit connected to the PC and a remote unit. Blocks of data are transmitted to the remote unit and the remote unit decodes and returns them. The transmitted and received data blocks are compared and the ratio of the results is calculated. **The Offline Link Test requires suspension of user network operation.**

Figure 31 - Offline Link Test Screen

Offline Link Test

Remote Select:

Local ID: 148

Remote ID: [Dropdown]

Start Clear

Pause Save

Blocks Tx'ed to Remote: 0

Responses from Remote: 0

Blocks Rx'ed from Remote: 0

Link Quality to Remote: 0.000 %

Link Quality from Remote: 0.000 %

Overall Link Quality: 0.000 %

of Blocks to Send: 0

Block Delay (s): 0.00 S

Close

- **Local ID**
This is the Short ID of the unit connected to the computer.
- **Remote ID**
Allows selection of the unit (by choosing its Remote ID) from which the Link Test information is gathered. Remote IDs are set up in the Diagnostic IDs and Alarms Screen.
- **Clear**
Allows the user to clear the display (blocks transmitted, responses received, blocks received and link quality).
- **Start**
Used to begin the test.
- **Pause**
Used to pause the test and allows the user to resume the test at a later time.

- **Save**
Allows the user to save the current Offline Link Test results to a file.

The Offline Link Test returns the following statistics:

- **Blocks Tx'ed to Remote**
Displays the number of data blocks transmitted to the remote unit.
- **Responses from Remote**
Displays the number of responses heard from the remote unit.
- **Blocks Rx'ed from Remote**
Displays the number of data blocks received from the remote unit.
- **Link Quality to Remote**
Displays the receive quality of the remote unit; the number of correctly decoded transmissions received by the remote divided by the number of total transmissions detected by the remote (in %).
- **Link Quality from Remote**
Displays the ratio of data blocks received to data blocks transmitted (in %).
- **Overall Link Quality**
Displays the overall link quality by combining the Link Quality to Remote ratio with the Link Quality from Remote ratio (in %).
- **# of Blocks to Send**
Allows the user to determine the number of blocks to send before stopping (with 0 being disabled).
- **Block Delay (s)**
Allows the user to determine the delay between the transmission of data blocks in 0.25 second intervals (0.00 to 10.00 seconds).

4.4.5 OFFLINE DIAGNOSTICS

From the Programmer Window, Select **Utilities – Offline Diagnostics** for user access to the **Get Diags** request. An Offline Diagnostics request requires suspension of user network operation.

Figure 32: Offline Diagnostics Screen

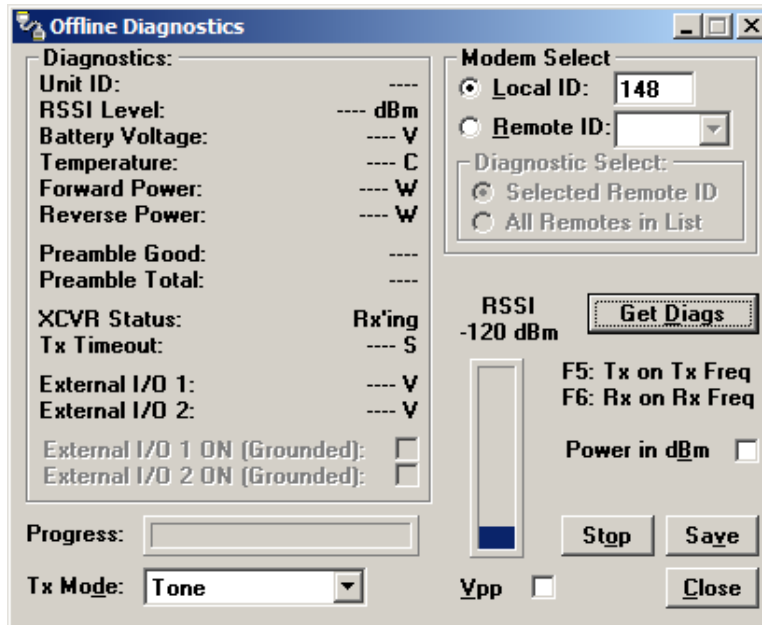

Offline Diagnostic parameters include the following:

- **Unit ID**
The Short ID of the unit sending diagnostics.
- **RSSI Level**
Received Signal Strength Indication in dBm.
- **Battery Voltage**
Supply voltage
- **Temperature**
Internal case temperature in Celsius.
- **Forward Power**
Forward power in watts or dBm.
- **Reverse Power**
Reverse power in watts or dBm.
- **Preamble Good**
The number of correctly decoded transmissions received in the last 15. Used with Preamble Total, this serves as an indication of how well the unit is receiving data.
- **Preamble Total**
The number of total transmissions detected, maximum is 15. Used with Preamble Good, this serves as an indication of how well the unit is receiving data.

- **XCVR Status**
Displays the status of the transceiver.
- **Tx Timeout**
A request for a remote unit to transmit causes the unit to transmit on the programmed transmit frequency until the Tx Timeout Timer expires. Program the Tx Timeout Timer in the Setup Modem/Radio Parameters/Radio Tab.
- **Progress**
The Progress panel shows the progress of the Get Diags request.
- **Tx Mode**
Allows the user to select different transmit modes when the unit is told to transmit:
 - Tone: the unit will transmit a 1200 Hz tone.
 - Mod Balance: the unit will transmit a 100 Hz square wave.
 - Random Data: the unit will transmit random data.
 - No Modulation: the unit will transmit with no modulation.
- **External I/O 1 (Pin 3 - Green Wire):**
When the I/O 1 connection of the Power - I/O Connector is configured as a Digital Output, External I/O displays the state of the open-collector transistor (ON-Grounded/OFF-Open). If configured as an Analog Input, External I/O displays the voltage on the connector (in volts). Programming of External I/O 1 is performed in the Setup Modem/Radio Parameters screen.
- **External I/O 2 (Pin 4 - White Wire):**
When the I/O 2 connection of the Power - I/O Connector is configured as a Digital Output, this displays the state of the open-collector transistor (ON - Grounded / OFF - Open). If configured as Analog Input, External I/O 2 displays the voltage on the connector (in volts). Programming of the External I/O 2 is performed in the Setup Modem/Radio Parameters screen.
- **External I/O 1 ON (Grounded):**
When the I/O 1 connection of the Power - I/O Connector is configured as a Digital Output, this checkbox is enabled to allow for the change of state of the open-collector output of Pin 3. Clicking on this check box causes immediate action to change the state of the output. This is true for local or a selected remote ID.
- **External I/O 2 ON (Grounded):**
When the I/O 2 connection of the Power - I/O Connector is configured as a Digital Output, this checkbox is enabled to allow for the change of state of the open-collector output on Pin 4. Clicking on this check box causes immediate action to change the state of the output. This is true for local or a selected remote ID.

Modem Select

- **Local ID**
Allows the user to send commands to the local unit (the unit interfaced to the computer). The Short ID for this unit is shown.

- **Remote ID**
Allows the user to send diagnostic commands to any specific remote unit and obtain its diagnostic information. The Remote ID is selected from the list of Remote IDs set up in the Diagnostic IDs and Alarms screen.

Diagnostic Select

- **Selected Remote ID**
This button allows the user to gather Offline Diagnostics from the selected Remote ID only.
- **Remote ID List**
This button allows the user to gather Offline Diagnostics from all the IDs in the list of Remote IDs (including the local unit).
- **Get Diags**
Allows the user to send the command for Offline Diagnostics. The command is sent to the unit connected to the computer if the Local ID button is selected. The command is sent to the selected Remote ID if the Remote ID and Selected Remote ID buttons are selected. The command is sent to the list of Remote IDs if the Remote ID and Remote ID List buttons are selected.
- **Stop**
Allows the user to stop any commands for Offline Diagnostics from being sent.
- **Save**
Allows the user to save the current Offline Diagnostics to a text file.
- **RSSI/Pwr**
Shows the current RSSI level (in dBm) while the local unit is receiving and the current Power Level (in watts or dBm) while the local unit is transmitting.
- **Rev Pwr**
Allows the user to view the reverse power instead of forward power while the local unit is transmitting.
- **F5**
Pressing the F5 key will cause the unit to transmit on the programmed transmit frequency.
- **F6**
Pressing the F6 key will cause the unit to go to receive on the programmed receive frequency.

Note: Commanding a remote unit to transmit will cause the unit to transmit on the programmed transmit frequency until the Tx Timeout Timer expires. Be sure to program the Tx Timeout Timer in the Setup Modem/Radio Parameters Screen

4.4.6 ONLINE DIAGNOSTICS

From the Programmer Window, Select **Utilities – Online Diagnostics**. Online Diagnostics are transmitted by each unit in a network before the user’s data is transmitted. All units must be programmed with the Online Diagnostics parameter found on the Setup Modem/Radio Parameters screen to receive Diagnostics from a system. The unit that the computer is

interfaced with will output Online Diagnostics as they are received. Using Online Diagnostics does not require suspension of network operation.

Online Diagnostics are subject to alarm conditions defined in Section XXX Diagnostic IDs and Alarms. When Online Diagnostics are received and a diagnostic field falls outside the alarm limits, value X will be designated as less than < or greater than > the allowed parameters.

Figure 33: Online Diagnostics

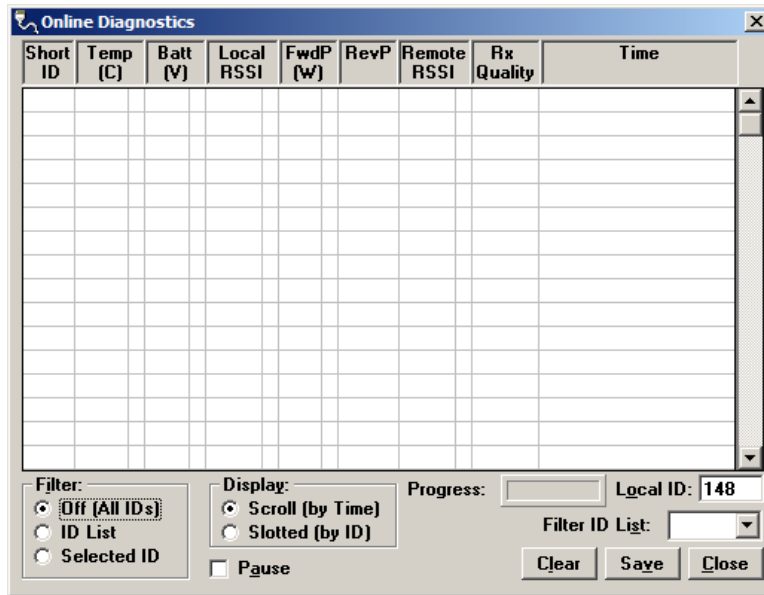

The following Online Diagnostics are gathered:

- **Short ID**
Displays the Short ID of the unit transmitting the diagnostics.
- **Temp**
Displays the internal case temperature (in Celsius) of the unit transmitting the diagnostics.
- **Batt**
Displays the supply voltage (in volts) of the unit transmitting the diagnostics.
- **Local RSSI**
If these are the diagnostics from a Remote Station, Local RSSI indicates the RSSI level of the Local Station obtained by the Remote Station transmitting these diagnostics. If these are the diagnostics from the Local Station, Local RSSI indicates the RSSI level of the Local Station from the last transmission of a Remote Station.
- **FwdP**
Displays the forward power (in watts) of the unit transmitting the diagnostics.

- **RevP**
 Reverse Power displays the approximate measure of reverse (reflected) power of the unit transmitting the diagnostics. This is represented as “Good” if the reverse power is within acceptable limits and is represented as “Bad” if the reverse power is too high. The threshold is set to approximately 1/4 the forward power.
- **Remote RSSI**
 If these are the diagnostics from a Remote Station, Remote RSSI indicates the RSSI level of the Remote Station from the last received transmission. If these are diagnostics from the Local Station, Remote RSSI indicates the RSSI level of the Remote Station last received at the local Station.
- **Rx Quality**
 Displays the receive quality (in %) of the remote unit. This is the number of correctly decoded transmissions received (in the last 15) divided by the number of total transmissions detected.
- **Time**
 The time stamp when the diagnostics were received.
- **Filter**
 Allows the user to filter Short IDs. The following options are available:
 - Off (All IDs): no IDs are filtered out.
 - ID List: only the IDs in the Filter ID List are shown.
 - Selected ID: only the selected ID in the Filter ID List is shown.
- **Display**
 Allows the user to format on screen data. The following options are available:
 - Scroll (by time): displays the diagnostics as they are received.
 - Slotted (by ID): sorts the diagnostics by Short ID. Using this option, each Short ID will have one row of diagnostics, showing the most recent.
- **Progress**
 This panel shows the sorting progress of the diagnostics if a filter was changed.
- **Local ID**
 The Short ID of the unit interfaced with the PC.
- **Filter ID List**
 This is a listing of Remote IDs setup in the Diagnostic IDs and Alarms Screen. This list is used for selecting a filter.
- **Pause**
 Allows the user to pause the reception of the diagnostics for scrolling through the grid.
- **Clear**
 Allows the user to clear the display and current Online Diagnostics.
- **Save**
 Allows the user to save the current Online Diagnostics to a file. A maximum of 4096 lines of data can be saved.

4.4.7 DIAGNOSTIC IDS AND ALARMS

From the Programmer Window, Select **Utilities – Diagnostics IDs and Alarms**

The Diagnostics IDs and Alarms screen allows the user to set up the ID List for use with the Offline Link Test, and Offline and Online Diagnostics as well as Alarms for use with Online Diagnostics.

Figure 34: Diagnostic IDs and Alarms Screen

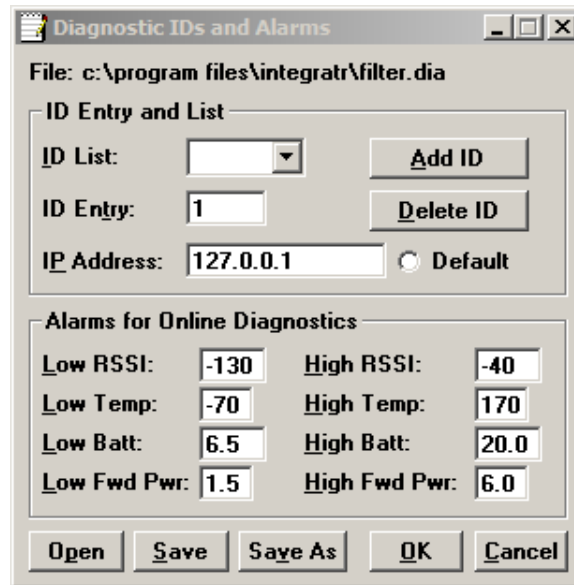

4.4.7.1 ID ENTRY AND LIST

- **ID Entry**
Allows the user to add Short IDs to the ID List. The range of this field is 1 to 1023 (ID 255 is reserved). A Short ID is added to the ID list by hitting Enter or by pressing the Add ID button.
- **ID List**
Allows the user to select a Short ID from the list to delete. A Short ID is deleted from the list by pressing the Delete ID button.
- **IP Address**
Allows the user to receive diagnostics through a serial to Ethernet converter with this IP Address. Default allows the user to select a default unit for the diagnostics when received through a serial to Ethernet converter.

4.4.7.2 ALARMS FOR ONLINE DIAGNOSTICS

Alarm indications are available with Online Diagnostics. When Online Diagnostics are received and a diagnostic field falls outside the Alarm limits, a “<” character will designate a value less than the low Alarm and a “>” character will designate a value greater than the High Alarm (See Figure 34).

- **Low/High RSSI**
Enter the high and low limits for acceptable RSSI levels (in dBm).
- **Low/High Temp**
Enter the high and low limits for acceptable temperature levels (in Celsius).
- **Low/High Batt**
Enter the high and low limits for acceptable battery voltage levels (in volts).
- **Low/High Fwd Pwr**
Enter the high and low limits for acceptable forward power levels (in watts).

4.4.8 USER TEST

From the Programmer Window, Select **Utilities – User Test**. The User Test utility is an Offline function and requires suspension of network operation.

Figure 35: User Test Screen

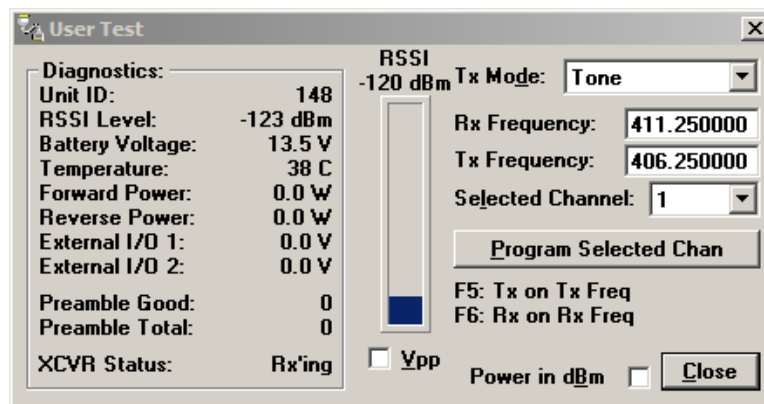

A User Test's diagnostic parameters include:

- **Unit ID**
The Short ID of the unit from which the diagnostics were received
- **RSSI Level**
Received Signal Strength Indication in dBm.
- **Battery Voltage**
Supply voltage in volts.
- **Temperature**
Internal temperature in Celsius.
- **Forward Power**
Forward power in watts or dBm.

- **Reverse Power**
Reverse power in watts or dBm.
- **External I/O 1**
Voltage on the External I/O 1 Input from the Power - I/O Connector (in volts).
- **External I/O 2**
Voltage on the External I/O Input from the Power - I/O Connector (in volts).
- **Preamble Good**
The number of correctly decoded transmissions received in the last 15. Used with Preamble Total, this serves as an indication of how well the unit is receiving data.
- **Preamble Total**
The number of total transmissions detected, maximum is 15. Used with Preamble Good, this serves as an indication of how well the unit is receiving data.
- **RSSI/Pwr**
This panel shows the current RSSI level (in dBm) while the local unit is receiving and the current power level (in watts or dBm) while the local unit is transmitting.
- **Rev Pwr**
This check box changes forward power to reverse power on the Power Panel from while the local unit is transmitting.
- **Power in dBm**
This check box allows the user to view Fwd/Rev Power in dBm (instead of watts).
- **Tx Mode**
This box allows the user to select different transmit modes when the unit is told to transmit.
 - Tone - the unit transmits a 1200 Hz tone
 - Mod Balance - the unit transmits a 100 Hz square wave
 - Random Data - the unit transmits random data
 - No Modulation - the unit transmits a carrier with no modulation
- **Rx/Tx Frequency**
Shows the current transmit frequencies
- **F5**
Pressing the F5 key will cause the unit to transmit on the programmed transmit frequency
- **F6**
Pressing the F6 key will cause the unit to go to receive on the programmed receive frequency

4.4.9 PACKET TEST

From the Programmer Window, Select **Utilities – Packet Test**

The Packet Test allows the user to simulate a Host/Remote polling environment. The Host will send out a packet to the Remote and the Remote will reply to the Master with the same packet information. This test is useful for testing the modem link.

Figure 36: Packet Test Screen

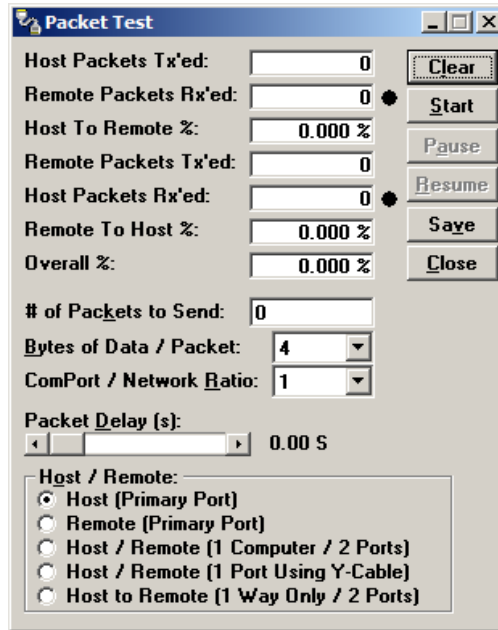

- **Host Packets Tx'ed**
Shows the number of data packet the Host device sent to the Remote
- **Remote Packets Rx'ed**
Shows the number of data packets the Remote device successfully received from the Host
- **Host to Remote %**
Shows the number of data packets the Remote device has successfully sent to the Remote
- **Remote Packets Tx'ed**
Shows the number of data packets the Remote device sent back to the Host
- **Host Packets Rx'ed**
Shows the number of data packets the Host device successfully received from the Remote
- **Remote to Host %**
Shows the percentage of data packets the Remote device successfully sent to the Host

- **Overall %**
Shows the percentage of Host received packets versus Host transmitted packets
- **# of Packets to Send**
A programmable number to tell the Host how many data packets to send to the Remote. After the programmed number of data packets are sent, the transmission will automatically stop
- **Bytes of Data/Packet**
A programmable number to tell the Host the number of data bytes to send in each packet. The Remote will respond with the same number of data bytes received
- **COM Port/ Network Radio**
The ratio of COM Port baud rate to network (over-the-air) baud rate of the modem. This is used if the network baud rate is slower than the COM Port baud rate. If the COM Port baud rate is 9600 and the network baud rate is 4800, set the ratio to 2. If the COM Port baud rate and the Network Baud Rate are the same, set the Ratio to 1
- **Packet Delay (s)**
Tells the Host the number of seconds to delay between sending each data packet (range is from 0.00 to 10.00 seconds in 0.25 second intervals)
- **Host/Remote**
Allows the user to choose the COM Port configuration
 - Host (Primary Port) - Configure the Primary COM Port as the Host device (the device initiating packets to the Remote device).
 - Remote (Primary Port) - Configure the Primary COM Port as the Remote device (the device responding to the packets from the Host device).
 - Host/Remote (1 computer / 2 ports) - Configure the Primary COM Port as the Host device and the Secondary COM Port as the Remote device. A computer with 2 COM Ports is required for this option.
 - Host/Remote (1 Port using a Y-cable) - A computer with 1 COM Port is typical for this option (See Table 8). Configure the Primary COM Port as the Host and Remote device. A Y-cable is required for this option (where Tx connections are split out to the transmitting device and the Rx connections are split out to the receiving device).

Table 8: Y-Cable Connections

Pin Name	DB-9	DB-25	Computer	Rx	Tx
DCD	1	8	X	X	-
RxD	2	3	X	X	-
TxD	3	2	X	-	X
DTR	4	20	-	-	-
GND	5	7	X	X	X
DSR	6	6	-	-	-
RTS	7	4	X	-	X
CTS	8	5	X	-	X
RI	9	22	-	-	-

4.4.10 ARRAY TEST

From the Programmer Window, Select **Utilities – Array Test**. The Array Test utility is used to send programmable length test packets. The packets are built using one of four possible patterns. For pattern descriptions, refer to Section XX.

Figure 37: Array Test Screen

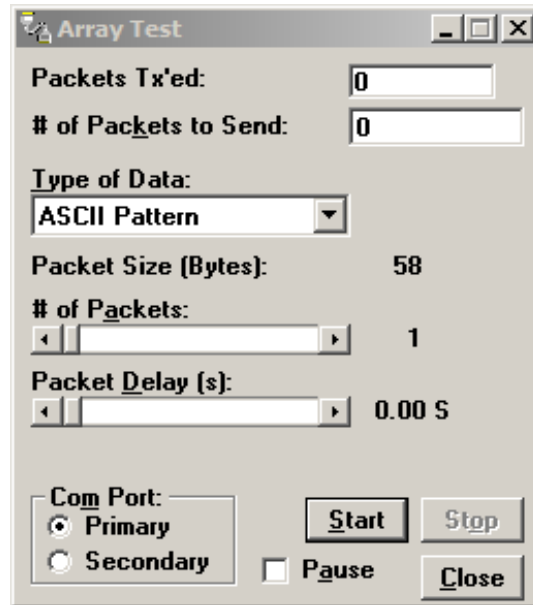

- **Packets Tx'ed**
Shows the total number of data packets transmitted
- **# of Packets to Send**
Shows the number of data packets to send before stopping (the range is 0 to unlimited)
- **Type of Data**
Select the data pattern for each data packet. The size and format for each pattern is shown in the pattern descriptions
- **Packet Size**
Shows the number of data bytes in each packet
- **# of Packets**
Shows the number of packets in each transmission
- **Packet Delay**
Shows the amount of time (in seconds) to delay between each packet transmission (range is from 0.00 to 30.00 seconds in 0.25 second intervals).
- **COM Port**
Select Primary or Secondary COM Port to be used for transmitting data.

4.4.10.1 PATTERN DESCRIPTIONS

ASCII Pattern

The ASCII Pattern Packet are 58 characters in length and have a sequence number at the beginning of each string, starting at 000, incrementing to 999 and wrapping around to 000 again. The pattern used to build the packets should have the following format (in ASCII):

```
000 ABCDEFGHIJKLMNOPQRSTUVWXYZabcdefghijklmnopqrstuvwxyz
001 ABCDEFGHIJKLMNOPQRSTUVWXYZabcdefghijklmnopqrstuvwxyz
- - -
998 ABCDEFGHIJKLMNOPQRSTUVWXYZabcdefghijklmnopqrstuvwxyz
999 ABCDEFGHIJKLMNOPQRSTUVWXYZabcdefghijklmnopqrstuvwxyz
000 ABCDEFGHIJKLMNOPQRSTUVWXYZabcdefghijklmnopqrstuvwxyz
001 ABCDEFGHIJKLMNOPQRSTUVWXYZabcdefghijklmnopqrstuvwxyz
```

ASCII Number Pattern

The ASCII Number Pattern are 54 characters in length and have a sequence number at the beginning of each string, starting at 000, incrementing to 999 and wrapping around to 000 again. The pattern used to build the packets should have the following format (in ASCII):

```
000 00 11 22 33 44 55 66 77 88 99 AA BB CC DD EE FF
001 00 11 22 33 44 55 66 77 88 99 AA BB CC DD EE FF
- - -
998 00 11 22 33 44 55 66 77 88 99 AA BB CC DD EE FF
999 00 11 22 33 44 55 66 77 88 99 AA BB CC DD EE FF
000 00 11 22 33 44 55 66 77 88 99 AA BB CC DD EE FF
001 00 11 22 33 44 55 66 77 88 99 AA BB CC DD EE FF
```

Binary Pattern

Binary Pattern packets are 16 characters in length and have a sequence number every 16 characters, starting at 0x00, incrementing to 0xFF and wrapping around to 0x00 again. The pattern used to build the packets should have the following format (in Hex):

```
00 11 22 33 44 55 66 77 88 99 AA BB CC DD EE FF
01 11 22 33 44 55 66 77 88 99 AA BB CC DD EE FF
02 11 22 33 44 55 66 77 88 99 AA BB CC DD EE FF
-- 11 22 33 44 55 66 77 88 99 AA BB CC DD EE FF
FE 11 22 33 44 55 66 77 88 99 AA BB CC DD EE FF
FF 11 22 33 44 55 66 77 88 99 AA BB CC DD EE FF
00 11 22 33 44 55 66 77 88 99 AA BB CC DD EE FF
01 11 22 33 44 55 66 77 88 99 AA BB CC DD EE FF
02 11 22 33 44 55 66 77 88 99 AA BB CC DD EE FF
-- 11 22 33 44 55 66 77 88 99 AA BB CC DD EE FF
```

Random Binary Pattern

Random Binary Pattern is 16 characters in length and contains random binary data.

4.4.11 PING TEST

From the Programmer Window, Select **Utilities – Ping Test**. The PING Test is used to simulate a Host/Remote polling environment. The Master sends out a packet to the Remote and the Remote replies to the Master with the same packet information.

Figure 38: Ping Test

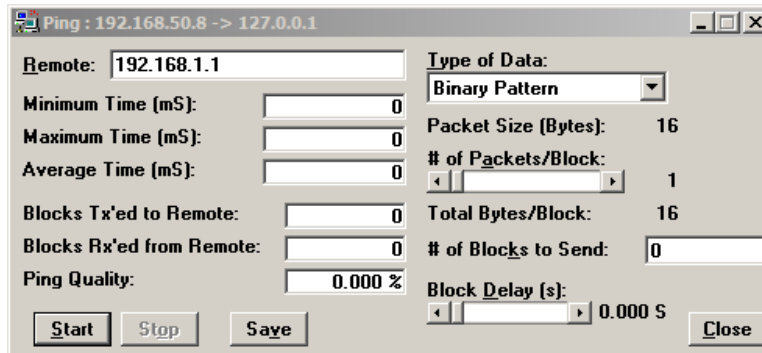

- **Remote**
Displays the IP Address of the device under test
- **Minimum Time**
Displays the minimum amount of time taken for the Ping Packet to echo back from the Remote device (in milliseconds).
- **Maximum Time**
Displays the maximum amount of time taken for the Ping Packet to echo back from the Remote device (in milliseconds).
- **Average Time**
Displays the average amount of time taken for the Ping Packet to echo back from the Remote device (in milliseconds).
- **Blocks Tx'ed to Remote**
Displays the number of data packets sent to the Remote device.
- **Blocks Rx'ed from Remote**
Displays the number of data packets received from the Remote device.
- **Ping Quality**
Displays the overall percentage of data packets sent vs. data packets received during the Ping Test.
- **Type of Data**
Displays the type of Data Pattern to be used for each packet.

The size for each Data Pattern is shown below in Packet Size. The following lists the formats of the Data Patterns:

ASCII Pattern

The packets will be 52 characters in length. The pattern used to build the packets will have the following format (in ASCII):

```
ABCDEFGHIJKLMNOPQRSTUVWXYZabcdefghijklmnopqrstuvwxyz  
ABCDEFGHIJKLMNOPQRSTUVWXYZabcdefghijklmnopqrstuvwxyz  
---  
ABCDEFGHIJKLMNOPQRSTUVWXYZabcdefghijklmnopqrstuvwxyz
```

ASCII Number Pattern

The packets will be 48 characters in length. The pattern used to build the packets will have the following format (in ASCII):

```
00 11 22 33 44 55 66 77 88 99 AA BB CC DD EE FF  
00 11 22 33 44 55 66 77 88 99 AA BB CC DD EE FF  
---  
00 11 22 33 44 55 66 77 88 99 AA BB CC DD EE FF
```

Binary Pattern

The packets will be 16 characters in length. The pattern used to build the packets will have the following format (in Hex):

```
00 11 22 33 44 55 66 77 88 99 AA BB CC DD EE FF  
00 11 22 33 44 55 66 77 88 99 AA BB CC DD EE FF  
---  
00 11 22 33 44 55 66 77 88 99 AA BB CC DD EE FF
```

Random Binary Pattern

The packets will be 16 characters in length and contain random binary data.

- **Packet Size**
Packet Size displays the number of bytes in each packet.
- **# of Packets/Block**
Displays the number of packets in each transmission block
- **Total Bytes/Block**
Displays the total number of blocks in each transmission block
- **# Blocks to Send**
Displays the number of blocks to be sent to the Remote device (after selected number has been sent, transmission automatically stops).
- **Block Delay**
Displays the amount of time (in seconds) of delay between each block transmission (range is from 0.000 to 5.000 seconds in 0.125 second intervals). Block Delay is user programmable.

- **Start**
Begins the Ping Test.
- **Stop**
Stops the Ping Test.
- **Save**
Offers the user the option to save the information received from the test.
- **Close**
Closes the Ping Test window.

4.4.12 ASCII/HEX TERMINAL

The ASCII and Hex Terminal Screens are accessed from the Utilities pull-down menu and allow the user to select an ASCII, Hexadecimal TCP Socket or UDP Socket Terminal Screen for the Primary and Secondary COM Ports (configured in the Port Settings screen - see Section 4.4.1) Data is sent according to the port configuration set up in the Port Settings screen.

4.4.12.1 ASCII TERMINAL

From the Programmer Window, Select Utilities – ASCII Terminal. ASCII Terminal configurations are defined below.

Figure 39: ASCII Terminal Screen

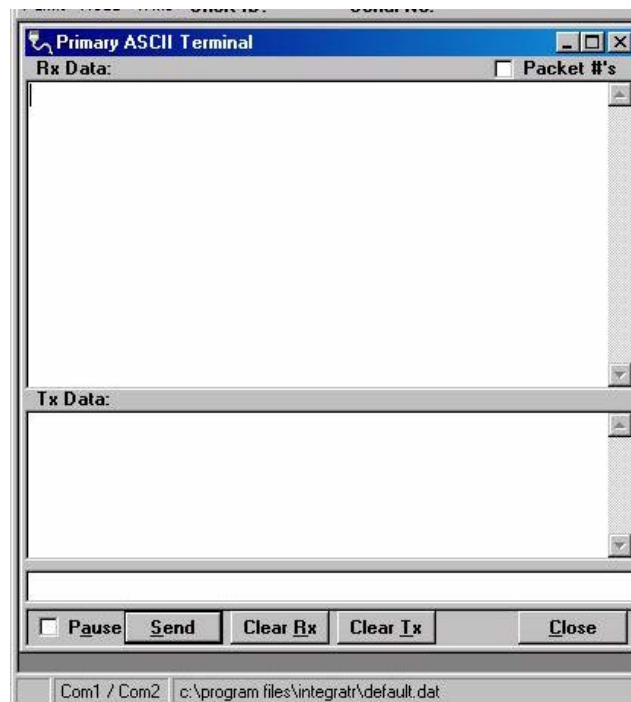

Primary

The Primary ASCII Terminal screen allows the user to send and receive ASCII data on the Primary COM Port (setup in the Port Settings screen).

Secondary

The Secondary ASCII Terminal screen allows the user to send and receive ASCII data on the Secondary COM Port (set up in the Port Settings screen).

TCP Socket

The TCP Socket Terminal screen allows the user to send and receive ASCII data over a TCP connection.

UDP Socket

The UDP Socket Terminal screen allows the user to send and receive ASCII data over a UDP connection.

4.4.12.2 HEX TERMINAL

From the Programmer Window, Select **Utilities – Hex Terminal**. Hex Terminal configurations are defined below.

Figure 40: HEX Terminal Screen

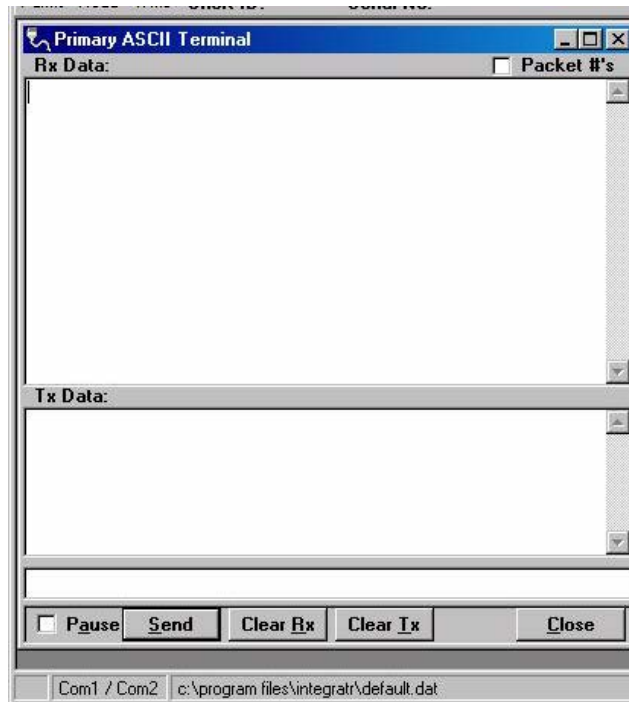

Primary

The Primary Hex Terminal screen selects a Hexadecimal Terminal screen to send and receive Hexadecimal data on the Primary COM Port (set up in the Port Settings screen).

Secondary

The Secondary Hex Terminal screen selects a Hexadecimal Terminal screen to send and receive Hexadecimal data on the Secondary COM Port (set up in the Port Settings screen).

TCP Socket

The TCP Socket Terminal screen allows the user to send and receive Hexadecimal data over a TCP connection.

UDP Socket

The UDP Socket Terminal screen allows the user to send and receive Hexadecimal data over a UDP connection.

4.5 PROGRAM CODE MENU

The **Program Code** pull-down menu allows the user to update the Integra-TR firmware (*.bin) with the **Program Firmware** option, **Read Boot Code Version**, **Select Firmware File** (allows the user to select the file to program the firmware in the Integra-TR) or **Upgrade Boot Code** file. Selecting one of these options opens a standard navigation window to select the desired file.

Figure 41: Select Firmware File Window (for reference only)



5 NETWORK OPTIMIZATION

Detailed system engineering is beyond the scope of this manual. However, there are some simple tips that can be used to optimize performance of a radio based SCADA or telemetry system.

5.1 CHOOSE THE BEST PROTOCOL

Some SCADA devices allow a choice of more than one operating protocol. In some cases, performance can be improved by selecting a different protocol. Contact Technical Service for assistance.

5.2 CHECK TIMER SETTINGS

Polling protocols issue a poll and wait a certain time for a response. Integra-TR adds a short amount of delay to each poll and response (typically in the order of 60 to 70 ms). Timer settings that are too short may cause erroneous indication of missed polls, in which case the application may retry or continue to cycle, ignoring the missed station. In this case, the response may collide with the next poll, further increasing errors. Setting an adequate timer margin will avoid problems and maximize performance.

5.3 AVOID FLOW CONTROL

Set the COM port baud rate to a value less than or equal to the radio network speed (2400, 4800, 9600 or 19200 b/s). In a polling system, this will prevent buffer overflow with possible missed transmissions. If the port baud rate must be set higher than the radio network speed, you may have to limit message length to prevent possible buffer overflow. Integra-TR will exert a flow control signal (CTS dropped) if buffers are almost full, but not all DTE honor such signals.

5.4 USE THE HIGHEST SUITABLE PORT BAUD RATE

Do not exceed the radio network speed. Operating an RTU at 1200 b/s on a 9600 b/s network will increase data transmission delays and reduce system performance.

5.5 EVALUATE THE NEED FOR ONLINE DIAGNOSTICS

Enabling online diagnostics increases delays by 2.5 to 20 ms (depending on speed). In critical applications, this extra delay can be eliminated by disabling online diagnostics. Offline Diagnostics (diagnostics on request) remain available.

5.6 INTERPRETING RSSI READINGS

Typical values of RSSI will be in the range of -110 to -60 dBm (depending on network speed), with higher values (i.e. less negative values) indicating a stronger signal.

Reliability of data reception depends largely on signal strength. Good design practice calls for a minimum 30 dB “fade margin”, based on a threshold reception level of -107 dBm (1 μ V) at speed of 9600 b/s. Experience indicates that this will give about 99.5% reliability.

Some representative performance values for 9600 b/s operation are given below. These values assume that the units are correctly aligned and installed in a quiet location. Environments with high electrical or RF noise levels will require an increase (less negative) in the numbers shown to achieve a given level of reliability.

- 100 dBm Approximately 50% reliability. Fading may cause frequent data loss.
- 90 dBm Approximately 90% reliability. Fading will cause occasional data loss.
- 80 dBm Approximately 99% reliability. Reasonable tolerance to most fading.
- 70 dBm Approximately 99.9% reliability with high tolerance to fading.

If RSSI values drops seasonally the most likely cause is tree foliage which can interfere with radio transmissions during the spring and summer.

5.7 INTERPRETING POWER READINGS

The values returned are approximate and should not be regarded as an absolute indicator of performance. For example, a unit that shows a forward power of 4.5 watts may actually measure at 5.0 watts on a lab quality wattmeter. For this reason, these values should not be used to indicate that a unit is out of spec or to compare one unit to another.

However, the values returned should be consistent for any given unit. If statistics are kept on a unit per unit basis, changes in forward or reflected power are significant. The following conditions are worthy of investigation.

1. Forward power output (in watts) drops or rises by more than 10% from its established value. Reflected power remains low. This indicates that the transmitter may need alignment or that a component may be in need of replacement.
2. Forward power output drops by more than 10% from its established value or reflected power shows an increase. This indicates a possible antenna or feedline problem that affects SWR (Standing Wave Ratio).

5.8 SWR AND REVERSE POWER

A reverse power reading above zero is an indication that the antenna, feedline or connectors are damaged, corroded or improperly tuned. This creates standing waves that are reported as a Standing Wave Ratio (SWR). Table 9 is based on a forward power of 5 watts (it may be scaled for lower power settings) and gives guidelines to interpreting these figures:

Table 9: SWR/Rev Power Interpretation

SWR	Rev Power	Significance
1:1	0	Ideal situation
1.5:1	0.2	Normal operation
2:1	0.6	Should be investigated
3:1 or greater	1.25 or greater	Defective antenna, feedline, or connectors

Should values returned by the built-in diagnostics seem to indicate a problem, verify using proper radio shop equipment.

6 DEFINITIONS

Dribble bits	Extraneous bits delivered at the end of a data transmission. These bits are equivalent to a “squelch tail” in voice systems.
COM Port	The Communications Port of the wireless device. This port is configured as DCE and is designed to connect directly to DTE.
CTS	Clear to Send. An RS-232 output signal from Integra-TR indicating that it is ready to accept data (used in RTS mode).
DCE	Data Communications Equipment. This designation is applied to equipment such as modems. DCE is designed to connect to DTE.
DOX	Data Operated Transmit. A mode of operation in which Integra-TR begins a transmission as soon as data is presented to the RS-232 port.
DTE	Data Terminal Equipment. This designation is applied to equipment such as terminals, PCs, RTUs, PLCs, etc. DTE is designed to connect to DCE.
FPS	Field Programming Software. Windows based software used in the programming and configuration of a variety of CalAmp serial products.
Full Channel	Radio channel bandwidth equal to 25 kHz
Half Channel	Radio channel bandwidth equal to 12.5 kHz
Multi-Channel	The Integra-TR has multi-channel capability under system PLC control for advanced network monitoring.
Network speed	Refers to the bit rate of the RF link between units. This rate is often different from COM port baud rate.
PLC	Programmable Logic Controller. An intelligent device that can make decisions, gather and report information, and control other devices.
Refarming	Strategy for using the radio spectrum more efficiently to meet future communications requirements and the FCC's minimum bit rate requirements with speeds up to 19200 in Full Channel and 9600 in Half Channel.
RTS	Request to Send. RS-232 input signal to Integra-TR indicating that the DTE has data to send. RTS may optionally be used as a transmit switch for Integra-TR.
RTS mode	A mode of operation in which Integra-TR begins a transmission when RTS is raised and continues transmitting until RTS is dropped.
RTU	Remote Terminal Unit. A SCADA device used to gather information or control other devices.
SCADA	Supervisory Control And Data Acquisition. A general term referring to systems that gather data and/or perform control operations.
Setup Port	The configuration / diagnostic port of Integra-TR. This port is designed to be connected to a PC running the Integra Field Programming Software.
Transparent	A transparent unit transmits all data without regard to special characters, etc.

ABOUT CALAMP

CalAmp is a leading provider of wireless communications products that enable anytime/anywhere access to critical information, data and entertainment content. With comprehensive capabilities ranging from product design and development through volume production, CalAmp delivers cost-effective high quality solutions to a broad array of customers and end markets. CalAmp is the leading supplier of Direct Broadcast Satellite (DBS) outdoor customer premise equipment to the U.S. satellite television market. The Company also provides wireless data communication solutions for the telemetry and asset tracking markets, private wireless networks, public safety communications and critical infrastructure and process control applications. For additional information, visit www.calamp.com.