

ANTENNAS | OMNI-402 SERIES

OMNI-DIRECTIONAL, MARINE & COASTAL LTE MIMO ANTENNA

410 MHz – 3800 MHz, 6.2 dBi



410 – 470 MHz: 698 – 2700 MHz: 3400 – 3800 MHz	6.2 dBi	Omni-Directional	4G LTE	5G Ready	410 – 470 MHz	CBRS Band
2.4 – 2.5 GHz	IoT & M2M	-40°C to +80°C	Fire Resistant	2x2 MIMO	IP 68	

APPLICATION AREAS

- Urban
- Rural/Farm
- Marine
- Transportation

- High performance wideband omni-directional marine antenna
- 2X2 MIMO capability for improved performance
- Easy mounting with feed through 1-inch marine standard adapter bracket included
- Robust and all-weather proof for harsh conditions at sea (IP 68)
- Various 316 stainless steel mounting brackets available optionally
- UV and saltwater protected against tempestuous weather conditions

Product Overview

The OMNI-402 is an ultra-wide band antenna, which covers all contemporary LTE operating frequencies with excellent balanced gain across all frequencies. The antenna also offers 2X2 MIMO capability from its vertically separated radiating elements, all in the same radome. The antenna design allows the antenna to have superior pattern control over the entire frequency range making the OMNI-402 a true high performance omni-directional MIMO antenna, suitable for marine and coastal applications. Usable in all parts of the world, the OMNI-402 guarantees signal reception almost everywhere. Poynting Antennas achieves this through new antenna configuration using multiple dipoles and a unique (patented) feed network. The antenna is future proof as it covers the 450 MHz LTE frequency band, which is becoming more popular in various regions and countries. This antenna is also 3400 – 3800 MHz capable for coastal and inland use.

Features

- Medium gain omni-directional antenna
- Antenna is purpose-built for marine and coastal operation
- UV and salt-water resistant
- Robust and weather resistant design with IP 68 rating
- 2X2 MIMO capable for improved performance
- Includes 3.5 GHz CBRS band and is 5G ready

Application Areas

- Marine applications / Yachts / Boats / Ferries
- Enhanced LTE reception
- IoT and M2M
- Poor data signal reception
- Improve data transmission connection reliability & stability
- Wi-Fi applications



Frequency Bands

PY-M-WS2-06W-M2-MA

©2020 USAT LLC. All rights reserved Product Specifications may change without prior notice Revised: September 2020

The OMNI-402 is an omni-directional antenna that works from 410 – 470 MHz | 698 – 960 MHz | 1710 – 2700 MHz | 3400 – 3800 MHz

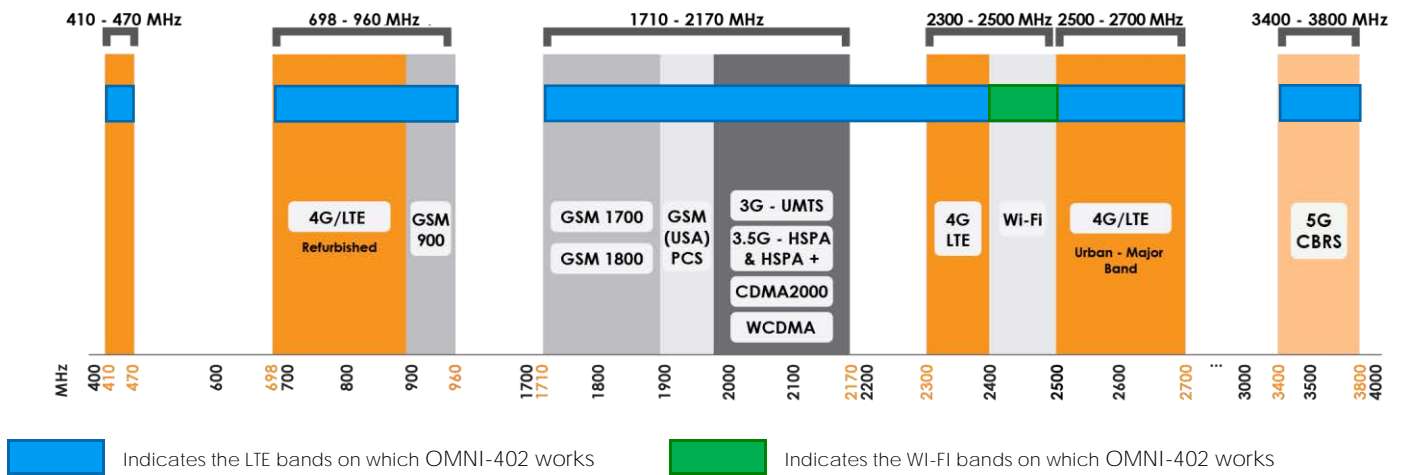

Antenna Overview

Ports	2
SISO / MIMO	2x2 MIMO
Frequency Bands	410 – 3800 MHz
Polarisation	Linear Vertical
Peak Gain	6.2 dBi
Coax Cable Type	Twin HDF 195
Coax Cable Length	2m
Connector Type	SMA (M)

**The coax cable & connector are factory mounted to the antenna*

Electrical Specifications

Frequency bands:	410 – 470 MHz 698 – 2700 MHz 3400 – 3800 MHz
Gain (max):	1 dBi @ 410-470 MHz 6.2 dBi @ 698-2700 MHz 2.5 dBi @ 3400-3800 MHz
VSWR:	<2.5:1 across 90% of the bands
Feed power handling:	10 W
Input impedance:	50 Ohm (nominal)
Coax cable loss:	0.25 dB/m @ 400 MHz 0.385 dB/m @ 900 MHz 0.565 dB/m @ 1800 MHz 0.666 dB/m @ 2400 MHz 0.788 dB/m @ 3000 MHz
DC short:	Yes

Product Box Contents

Antenna:	A-OMNI-0402
Mounting bracket:	1" (14 TPI) Marine Adapter (BRKT-40) & L-bracket (Ø30-50mm Pole)

Ordering Information

Commercial name:	OMNI-402
Order product code:	PY-M-WS2-06W-M2-MA
EAN number:	0707273470393

Mechanical Specifications

Product dimensions	750 mm x Ø75 mm (Incl. BRKT-40)
Packaged dimensions:	704 mm x 147 mm x 100 mm
Weight:	0.86 kg
Packaged weight:	1.7 kg
Radome material:	UV Stable Marine ASA
Radome colour:	Brilliant White Pantone P 179-1 C
Mounting Type:	Standard 1" -14 TPI marine mount & Wall/pole mount

Environmental Specifications, Certification & Approvals

Wind Survival:	<160 km/h
Temperature Range (Operating):	-40°C to +80°C
Environmental Conditions:	Outdoor/Indoor
Water ingress protection ratio/standard:	IP 68
Salt Spray:	MIL-STD 810F/ASTM B117
Operating Relative Humidity:	Up to 98%
Storage Humidity:	5% to 95% - non-condensing
Storage Temperature:	-40°C to +80°C
Enclosure Flammability Rating:	UL 94-HB
Impact resistance:	IK 08
Product Safety & Environmental:	Complies with CE and RoHS standards



Antenna Performance Plots

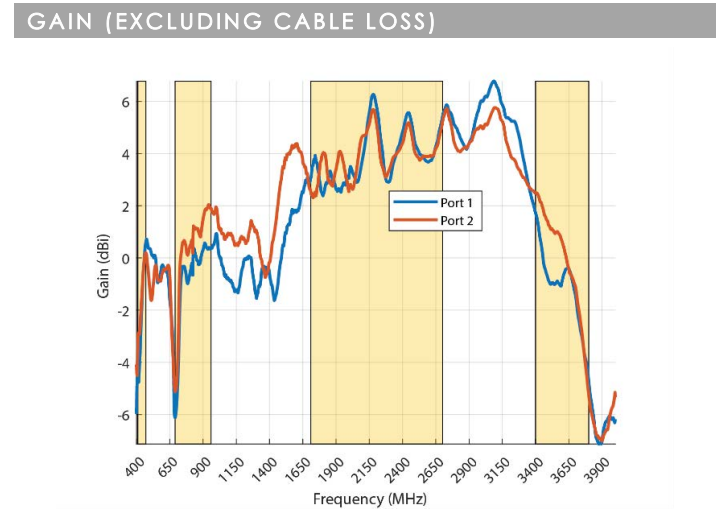
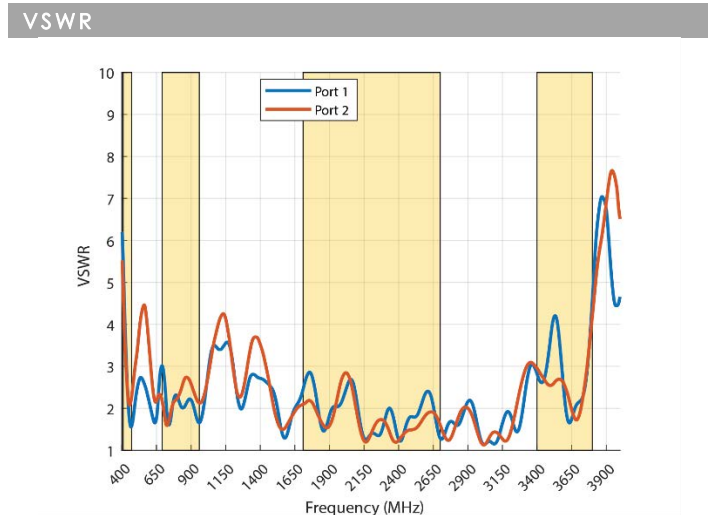

Voltage Standing Wave Ratio (VSWR)

VSWR is a measure of how efficiently radio-frequency power is transmitted from a power source, through a transmission line, into a load. In an ideal system, 100% of the energy is transmitted which corresponds to a VSWR of 1:1.

The OMNI-402 delivers superior performance across all bands with a VSWR of $\leq 2.5:1$ or better across 90% of the bands.

Gain* in dBi

6.2 dBi is the peak gain across all bands from 410 – 3800 MHz

Gain @ 410 – 470 MHz:	1 dBi
Gain @ 698 – 2700 MHz:	6.2 dBi
Gain @ 3400 – 3800 MHz:	2.5 dBi

*Antenna gain measured with polarisation aligned standard antenna

Technical Drawings

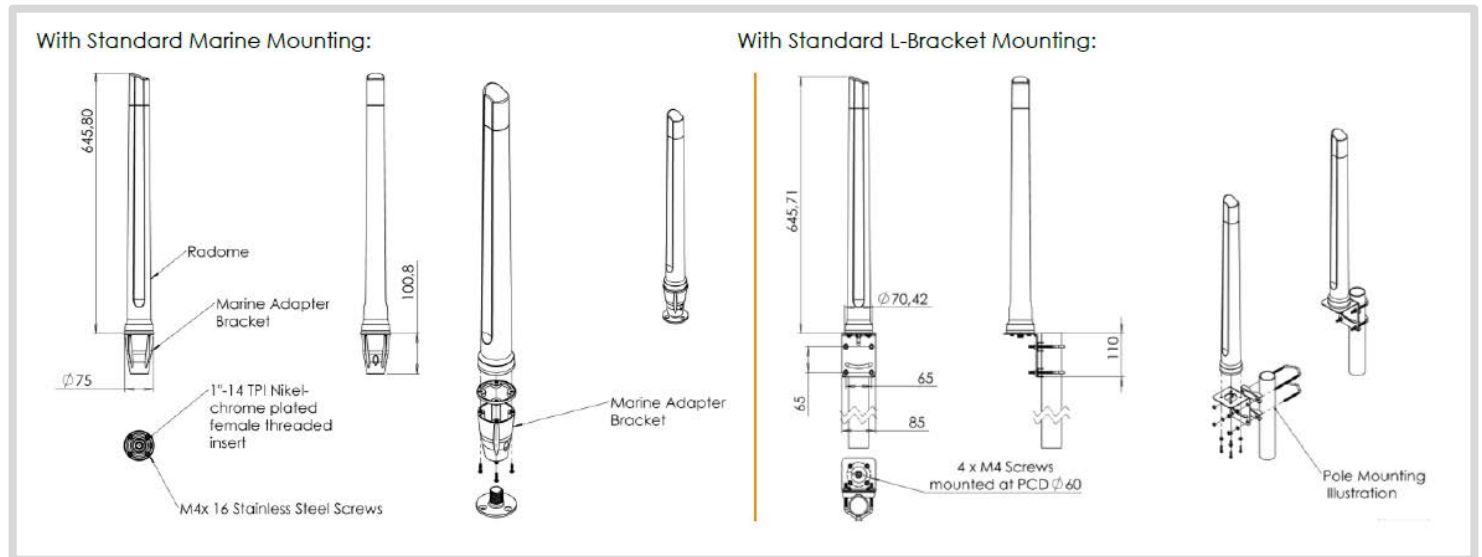

Radiation Patterns

Azimuth (Top View): 410–470 MHz Azimuth (Top View): 698–960 MHz Azimuth (Top View): 1710–2100 MHz

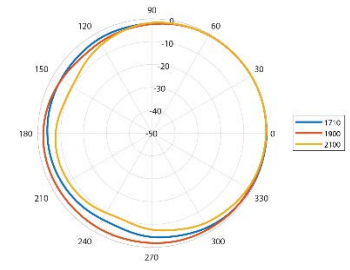
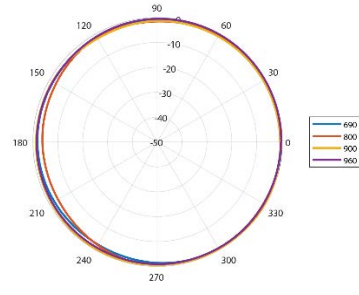
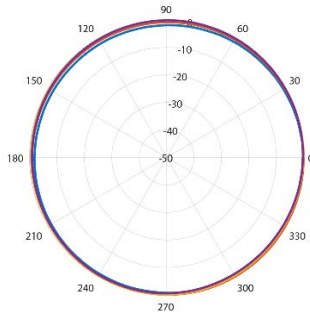

Azimuth (Top View): 2300–2700 MHz Azimuth (Top View): 3400–3800 MHz Elevation 1 (Side View): 410–470 MHz

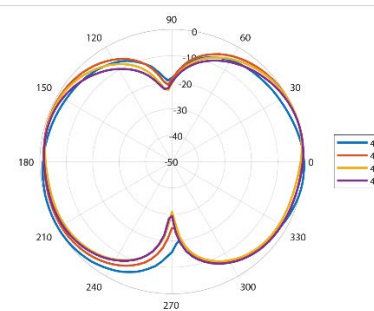
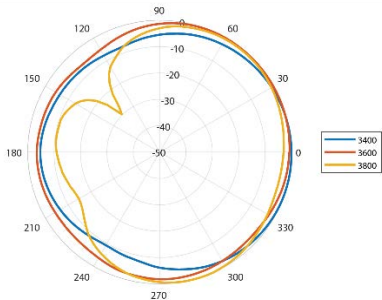
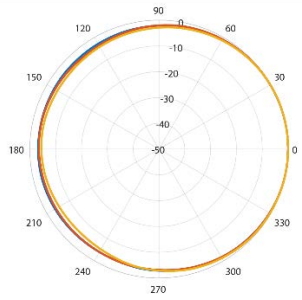

Elevation 1 (Side View): 698–960 MHz Elevation 1 (Side View): 1710–2100 MHz Elevation 1 (Side View): 2300–2700 MHz

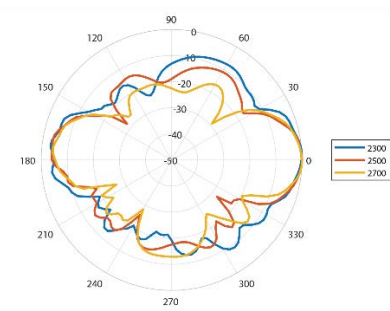
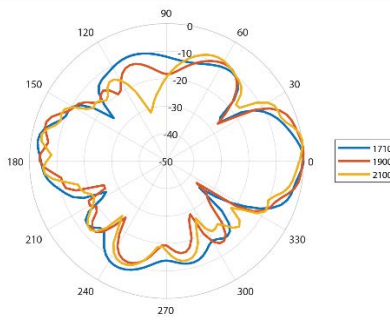
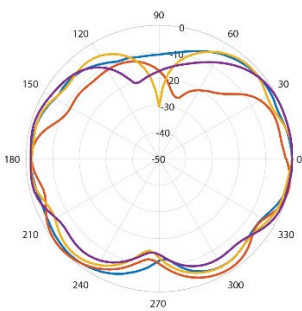

Elevation 1 (Side View): 3400–3800 MHz Elevation 2 (Side View): 410–470 MHz Elevation 2 (Side View): 698–960 MHz

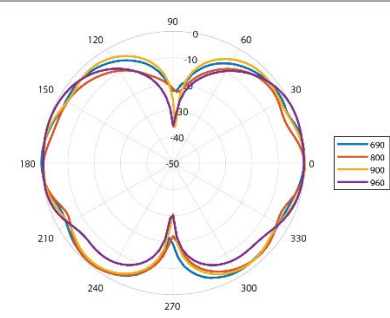
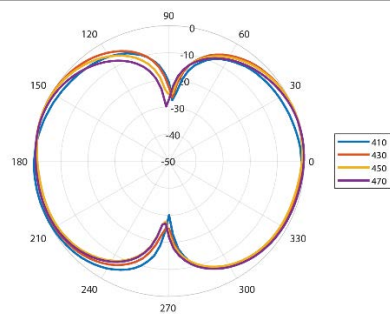
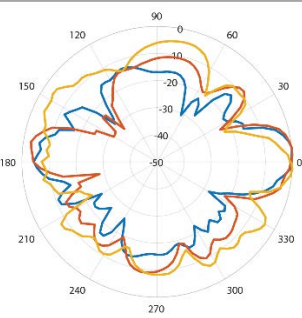

Elevation 2 (Side View): 1710–2100 MHz Elevation 2 (Side View): 2300–2700 MHz Elevation 2 (Side View): 3400–3800 MHz

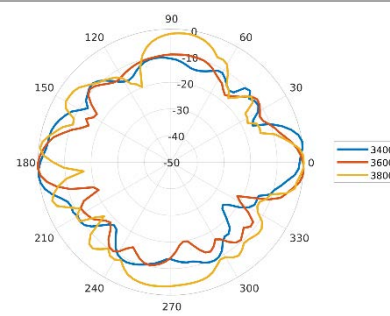
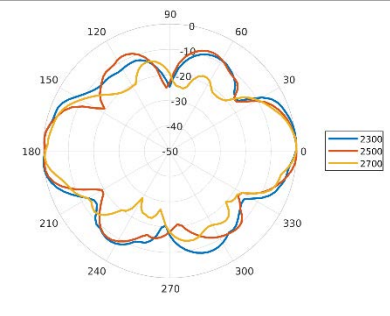
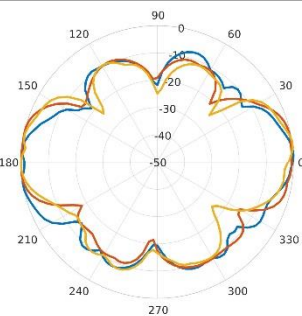

Mounting Options

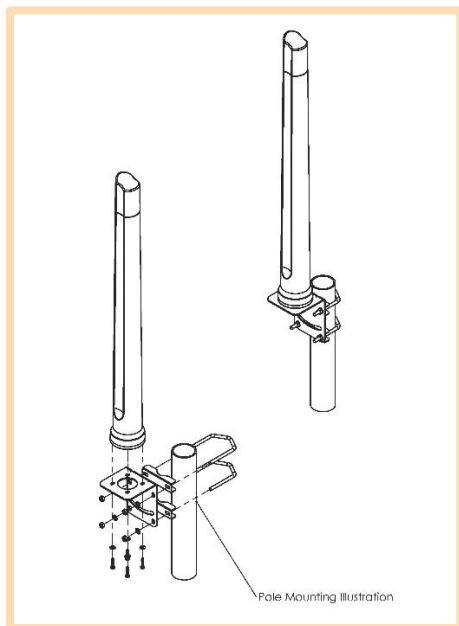

Pole Mount

L-Bracket 316 Stainless Steel – included
(for Ø 30-50mm pole)

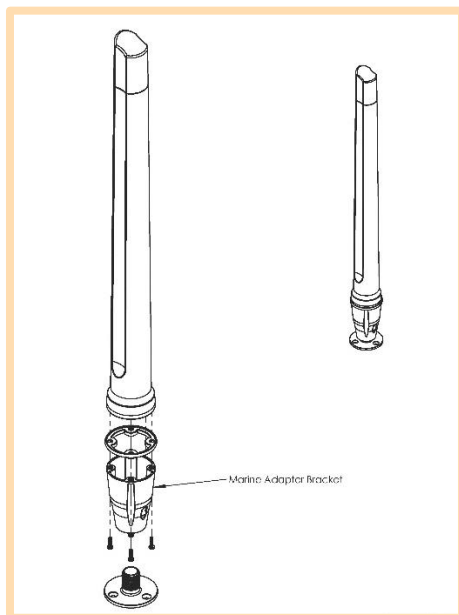

Marine Bracket Mount

1" -14 TPI female adapter – included
Mounts to standard marine brackets:

- BRKT-37: Flat Mount - Optional
- BRKT-38: Ratchet Mount - Optional
- BRKT-39: Rail Mount - Optional

See Optional Accessories below

Also available: BRKT-41 with 1.25" – 11TPI female adapter (Optional)
See Accessories below

Additional Accessories



BRKT-37

Marine flat mount antenna bracket 1"-14TPI 316 Stainless Steel



BRKT-38

Marine ratchet rail mount antenna bracket 1"-14TPI 316 Stainless Steel



BRKT-39

Heavy duty marine mount antenna bracket 1"-14TPI 316 Stainless Steel

See accessories technical specifications on www.poynting.tech

Contact Us

USAT | Connect What's Critical™

605 Eastowne Drive
Chapel Hill, NC 27514

Phone: (919) 942-4212
E-mail: info@usatcorp.com
Web: <https://usatcorp.com>