

ANTENNAS | HELI-22 SERIES

CIRCULAR POLARISED, BI-DIRECTIONAL MINE/TUNNEL ANTENNA

Dual-band Wi-Fi, 2400 - 2500 MHz, 9 dBi; 5000 - 6000 MHz, 11 dBi



 2400-2500 MHz 9 dBi; 2.4GHz 5000-6000MHz 11 dBi; 5 GHz		 Bi-Directional	 Machine to Machine	 IoT	 2.4 – 2.5 GHz 5.0 – 6.0 GHz
 2X2 MIMO Possible with RHC & LHC combined	 Chemical Protection	 IP 65	 -40°C to +70°C	 Fire Resistant	

- Circular Polarised HELI antenna provides enhanced signal propagation and connection stability within a tunnel
- Left-hand Circular (LHC) & Right-Hand Circular (RHC) polarised
- Uni-directional – radiates in one direction in a tunnel
- Ruggedized, water and dust ingress protected (IP 65)
- Ideal for Mining & Tunnel M2M and IoT deployments

APPLICATION AREAS

- Mining
- Tunnelling
- MASC Mining and Surface

Product Overview

The HELI-22 forms part of a series of Mini-HELI antennas. These antennas are only mini in size relative to their bigger brothers, the HELI-3, HELI-4 & HELI-8, but offer medium to high gain, which makes these antennas ideal for mining tunnels where IoT/M2M connectivity is deployed and can also be used for coverage into the stopes.

The HELI-22 is a dual-band 2.4 GHz and 5 GHz Wi-Fi antenna, radiating in both directions (i.e. bi-directional). This makes them ideal for the coverage of both Wi-Fi bands in mining and other type of tunnels. These antennas are typically used for the deployment of IoT within the tunnel to provide telemetry and mine automation. These antennas are available in both Left-hand Circular (LHC) & Right-Hand Circular (RHC) polarised antenna elements to provide optimal decorrelation within a MIMO deployment when using the BRKT-45, resulting in optimum performance. The decorrelation is due to the polarisation difference and spatial diversity, between the two antenna elements, which enhances MIMO performance and RF reliability within a mining tunnel. The dual-band Wi-Fi connection propagates around tunnel bends in a Non-Line of Sight scenario and provides immunity to many Wi-Fi signal disrupting objects such as trains and drilling machinery which appear to obscure the tunnel

Features

- Four port 2.4 GHz and 5 GHz Wi-Fi antenna
- This antenna is especially designed for mining and other types of tunnels where rapid extension of network is required
- Bi-directional – radiates in both directions in a tunnel
- Left & Right-hand Circular Polarised

Application Areas

- Supplementing fibre/leaky feeder cable “Hotspots” to areas to enhance mobility or extend networks to inaccessible areas
- Underground telemetry and automation
- Creating of complete underground in tunnel wide data networks and internet/LTE connectivity
- Seamless connection to personnel using cellular phones and smart devices and tablets



Frequency Bands

The HELI-22 is a Wi-Fi / ISM antenna that works from 2400 – 2500MHz & 5000 – 6000 MHz

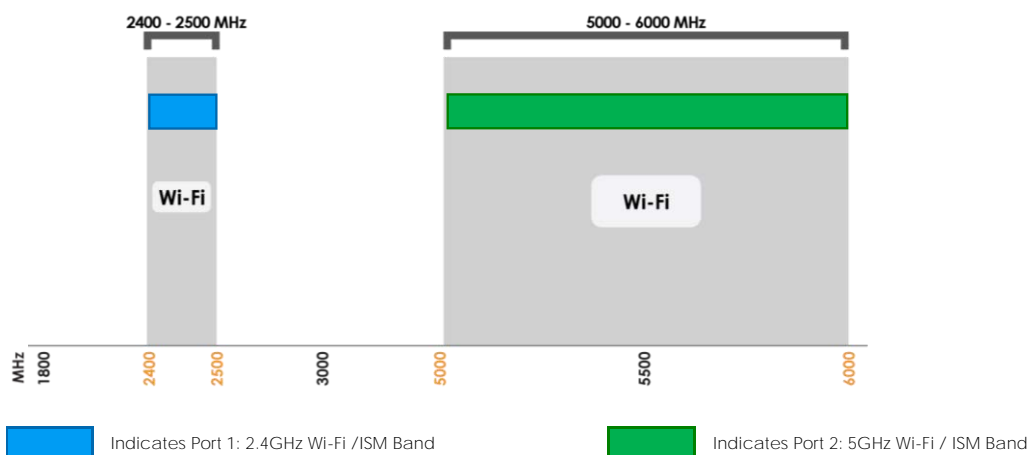

Antenna Overview

Product Order Code (SKU)	A-HELI-0022-V2-01	A-HELI-0022-V2-02
Ports	4	4
SISO / MIMO	2x2 MIMO	2x2 MIMO
Coax Cable Type	RG 58	RG 58
Coax Cable Length	350 mm	350 mm
Connector Type	N-Type (M)	N-Type (M)
Included Mounting Bracket	A-BRKT-045-V2-01	A-BRKT-045-V2-01 and A-BRKT-047-V1-01
EAN	6009710920060	6009710920275

*The coax cable & connector is factory mounted to the antenna

Electrical Specifications

Frequency bands:	2400 MHz - 2500 MHz 5000 MHz - 6000 MHz
Gain (max):	9 dBi @ 2400 MHz – 2500 MHz 11 dBi @ 5000 MHz - 6000 MHz
VSWR:	<2:1 Over 90% of the bands
Feed power handling:	30 W
Input impedance:	50 Ohm (nominal)
Polarisation:	Circular Polarised (LHC and RHC)
Coax cable loss:	0.97 dB/m @ 2400 MHz 2.0 dB/m @ 5800 MHz
DC short:	N/A

Product Box Contents

Antenna:	A-HELI-0019-V2-01-RH A-HELI-0019-V2-01-LH
----------	--

Mechanical Specifications

Product dimensions	603 mm x 415 mm x 266 mm
Packaged dimensions:	665 mm x 465 mm x 325 mm
Weight:	5.6 kg
Packaged weight:	5.9 kg
Radome material:	ABS & PVC
Radome colour:	Grey
Mounting Type:	Ceiling mounted

Environmental Specifications, Certification & Approvals

Wind Survival:	≤120 km/h
Temperature Range (Operating):	-40°C to +70°C
Environmental Conditions:	Outdoor/Indoor
Water ingress protection ratio/standard:	IP 65
Salt Spray:	MIL-STD 810F/ASTM B117
Operating Relative Humidity:	Up to 98%
Storage Humidity:	5% to 95% - non-condensing
Storage Temperature:	-40°C to +70°C
Enclosure Flammability Rating:	UL 94-HB
Impact resistance:	IK 08
Product Safety & Environmental:	Complies with CE and RoHS standards



Antenna Performance Plots

VSWR 2400-2500 MHz

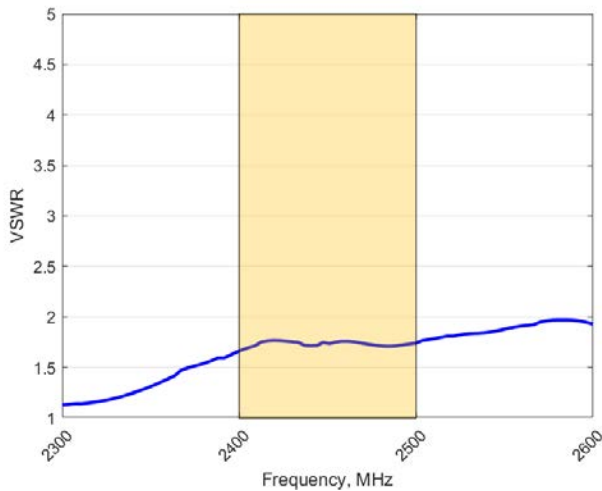

Voltage Standing Wave Ratio (VSWR)

VSWR is a measure of how efficiently radio-frequency power is transmitted from a power source, through a transmission line, into a load. In an ideal system, 100% of the energy is transmitted which corresponds to a VSWR of 1:1.

The HELI-22 delivers superior performance across all bands with a VSWR to 2:1 or better across 90% of the bands.

VSWR 5000-6000 MHz

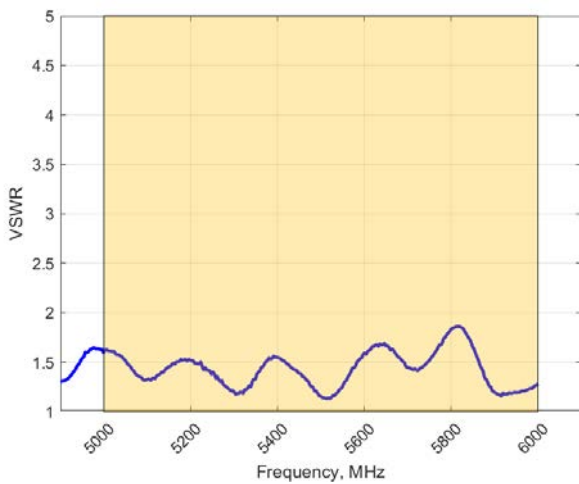

Voltage Standing Wave Ratio (VSWR)

VSWR is a measure of how efficiently radio-frequency power is transmitted from a power source, through a transmission line, into a load. In an ideal system, 100% of the energy is transmitted which corresponds to a VSWR of 1:1.

The HELI-22 delivers superior performance across all bands with a VSWR of <2:1 or better across 90% of the bands.

GAIN 2400-2500 MHz (EXCLUDING CABLE LOSS)

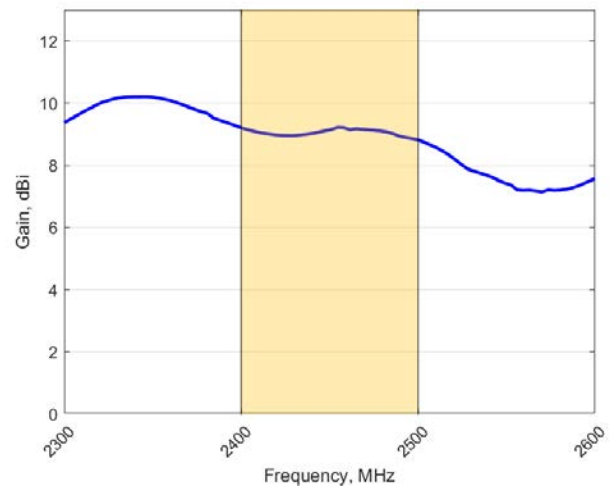

Gain* in dBi

9 dBi is the peak gain from 2400 – 2500 MHz

*Antenna gain measured with circular polarised standard antenna

GAIN 5000-6000 MHz (EXCLUDING CABLE LOSS)

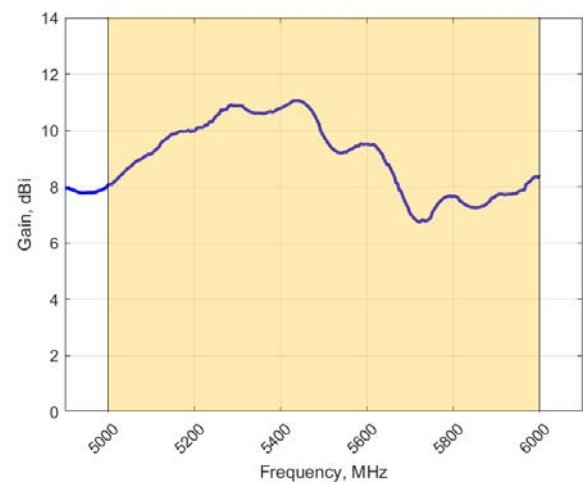

Gain* in dBi

11.0 dBi is the peak gain from 5000 – 6000 MHz

*Antenna gain measured with circular polarised standard antenna

Technical Drawings

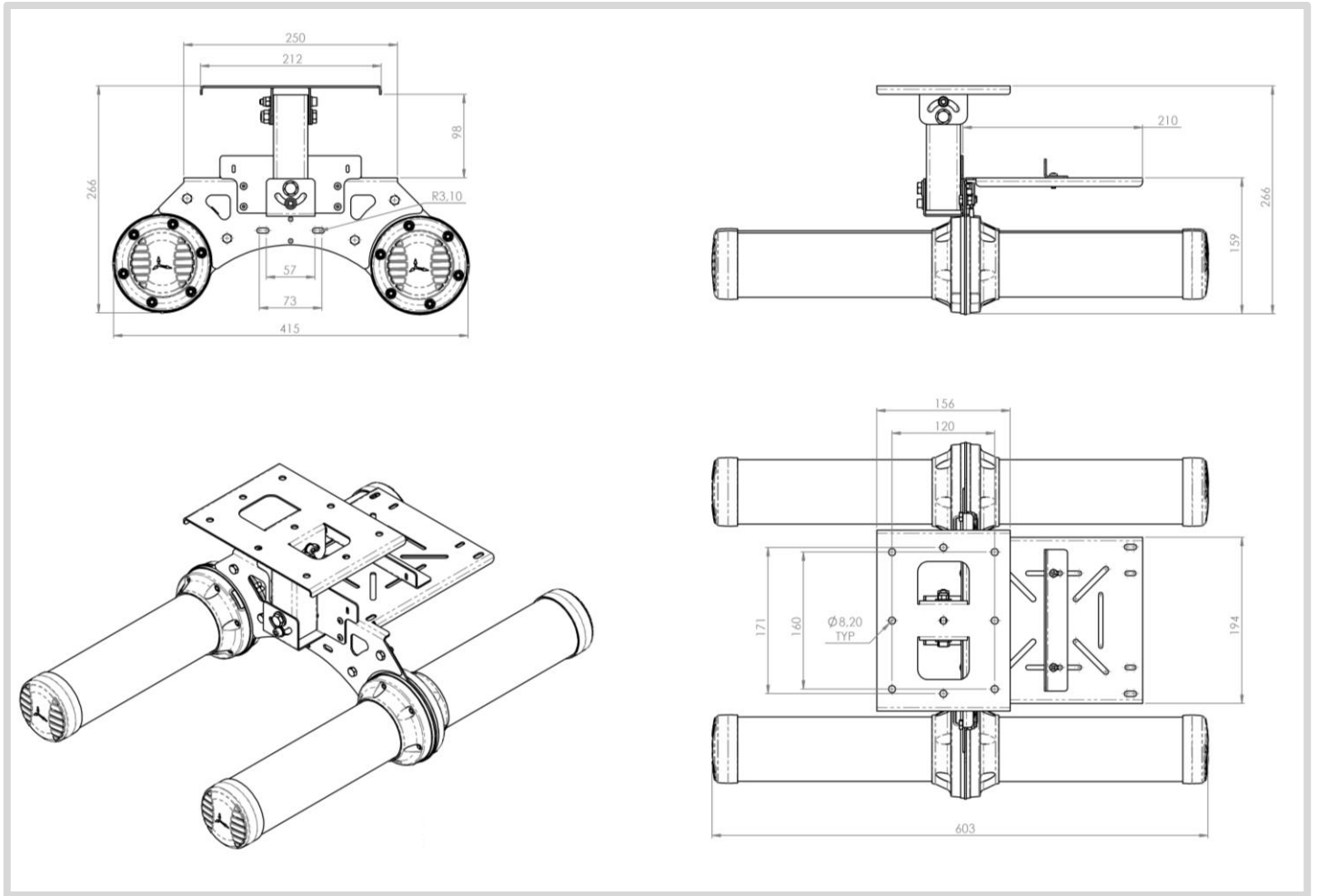

Radiation Patterns

Elevation Port 1 & 3: 2400 – 2500MHz | Elevation Port 2 & 4: 5000 – 6000 MHz

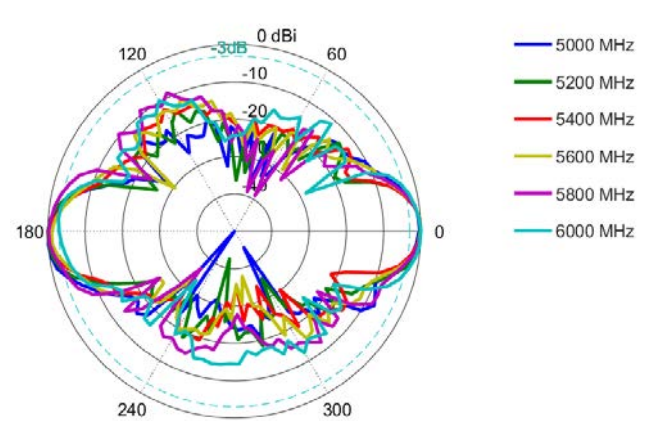
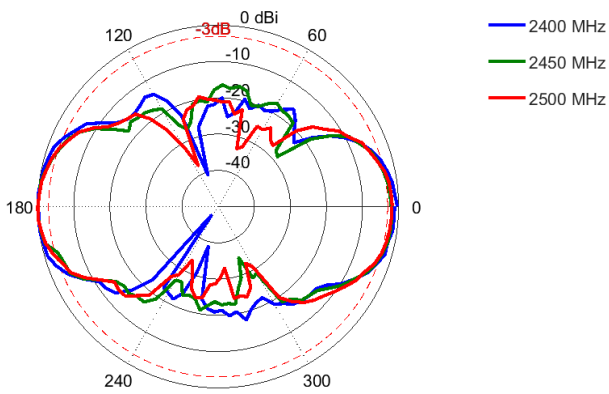

Azimuth Port 1 & 3: 2400 – 2500MHz | Azimuth Port 2 & 4: 5000 – 6000 MHz

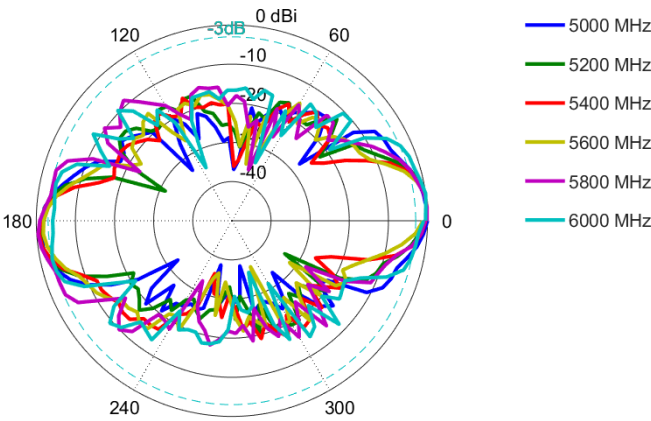
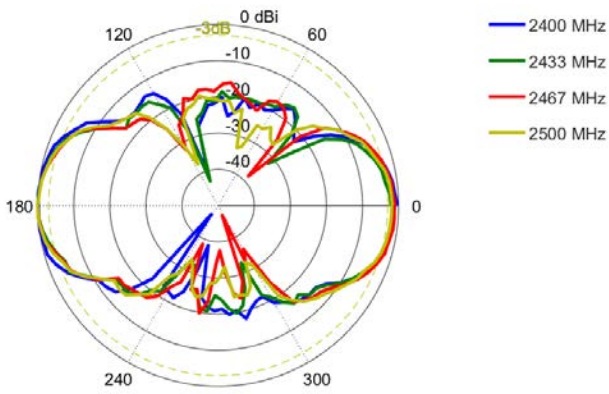

Antenna Assembly Options

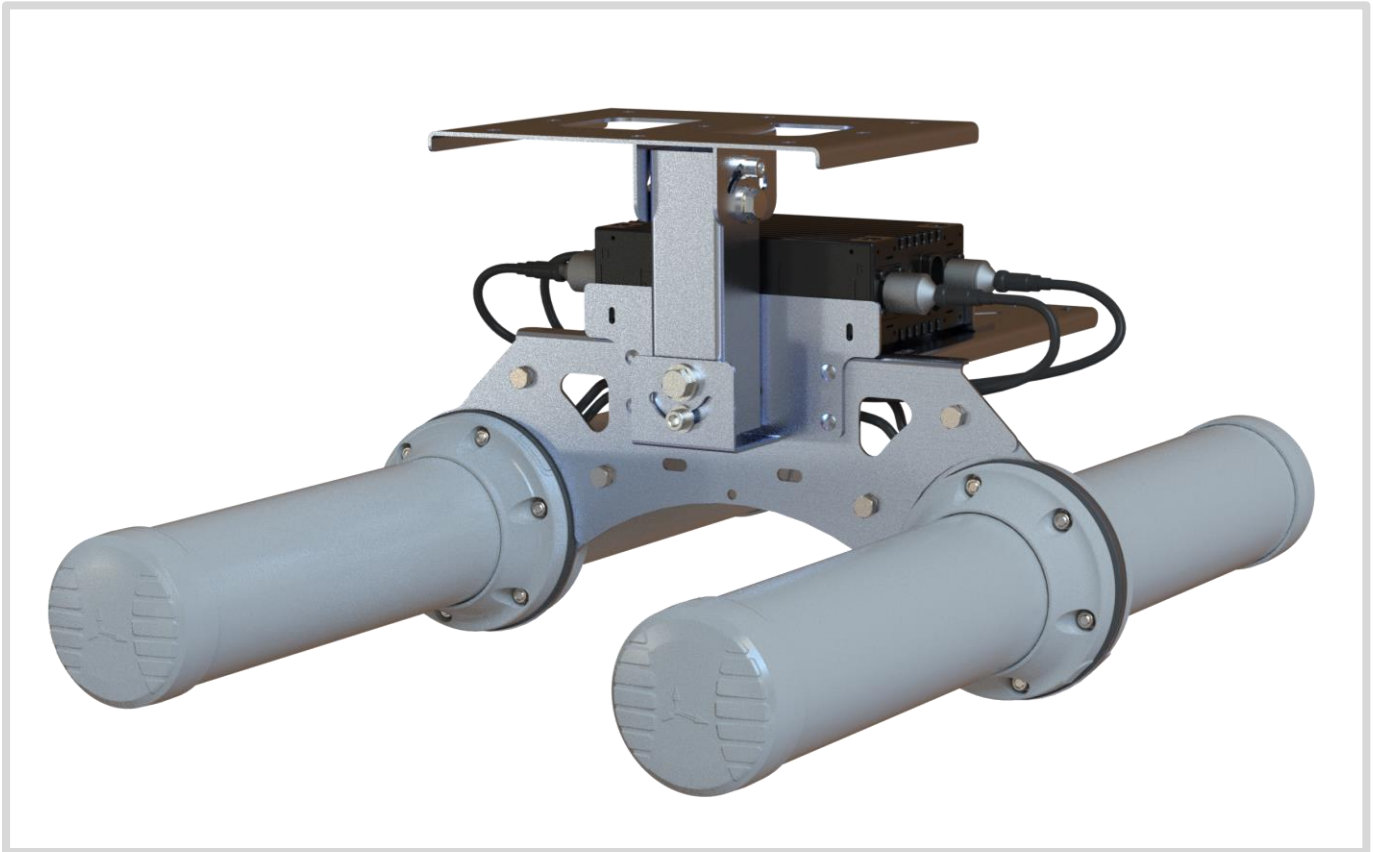

Complete assemblies available with antennas and brackets:

A-HELI-0022-V2-01 consists of:

- A-HELI-0019-V2-01-LH _ Left-hand, Circular polarised bi-directional antenna
- A-HELI-0019-V2-01-RH _ Right-hand, Circular polarised bi-directional antenna
- A-BRKT-045-V2-01 _ Ceiling Mount, swivel bracket

A-HELI-0022-V2-02 consists of:

- A-HELI-0019-V2-01-LH _ Left-hand, Circular polarised bi-directional antenna
- A-HELI-0019-V2-01-RH _ Right-hand, Circular polarised bi-directional antenna
- A-BRKT-045-V2-01 _ Ceiling Mount, swivel bracket
- A-BRKT-047-V1-01 _ Mine roof bolt attachment accessory

Mounting Options

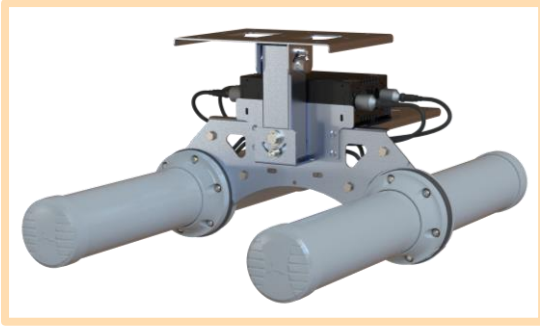

Ceiling Mount

Multi directional swivel bracket for mounting the antenna to a ceiling.
This option uses A-BRKT-045-V2-01.



Roof Bolt Mounting

This optional 20mm roof bolt mounting bracket attachment is used in conjunction with BRKT-45 for mounting to standard mine roof bolts.
This option uses A-BRKT-047-V1-01.

Contact Us

USAT | Connect What's Critical™

605 Eastowne Drive
Chapel Hill, NC 27514

Phone: (919) 942-4214

E-mail: info@usatcorp.com

Web: <https://usatcorp.com>
